

PRODUCTS

The *Motion Coordinator* system is extremely modular, allowing the user to tailor the controller to their specific applications, this also allows the flexibility to incorporate new modules if the need should change, making the system “future proof”. Systems may be used with a stand alone program or alternatively commands can be sent from an external computer.

All *Motion Coordinators*, whether panel mount, rack mount, DIN-rail mount or a custom design format, allow digital or analogue I/O expansion with Trio's I/O modules. Special I/O requirements can also be accommodated using the CANopen protocol to control third party I/O modules. The Flexslice System offers fast high performance EtherCAT devices for Trio's range of EtherCAT *Motion Coordinators*.

Trio's UNIPLAY range of operator interfaces provide a robust and functional HMI using the Ethernet network. Third party HMI products, touchscreens, etc. can communicate to the *Motion Coordinator* via the Modbus-RTU serial protocol.

System Set-Up

The MC4/5/6 range includes advanced networking technology for connection to Digital Servos, CANbus and Factory Networks. Access to all parts of the system by network connections allows reduced down-time with automated fault reporting and analysis.

With a MC664 *Motion Coordinator*, it is possible to control a machine with up to 128 axes (64 stepper/servo and 64 virtual), 1024 digital inputs, 1024 digital outputs, 32 analogue inputs and 16 analogue outputs.

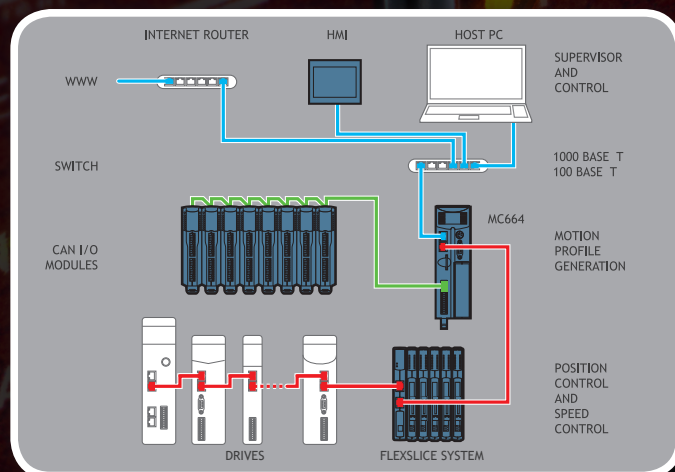

Preliminary specifications may change without notice

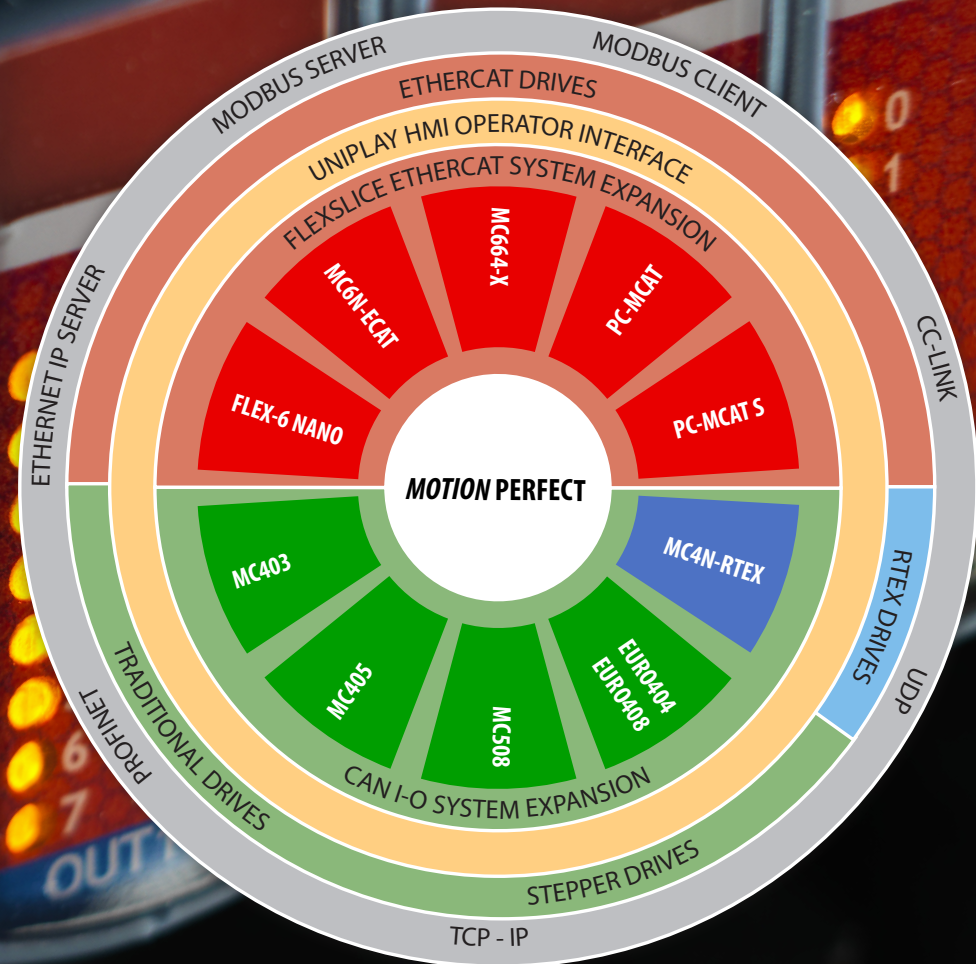

UK | USA | CHINA | INDIA | WWW.TRIMOTION.COM



FLEX-6 NANO

64 Axis EtherCAT Motion Coordinator

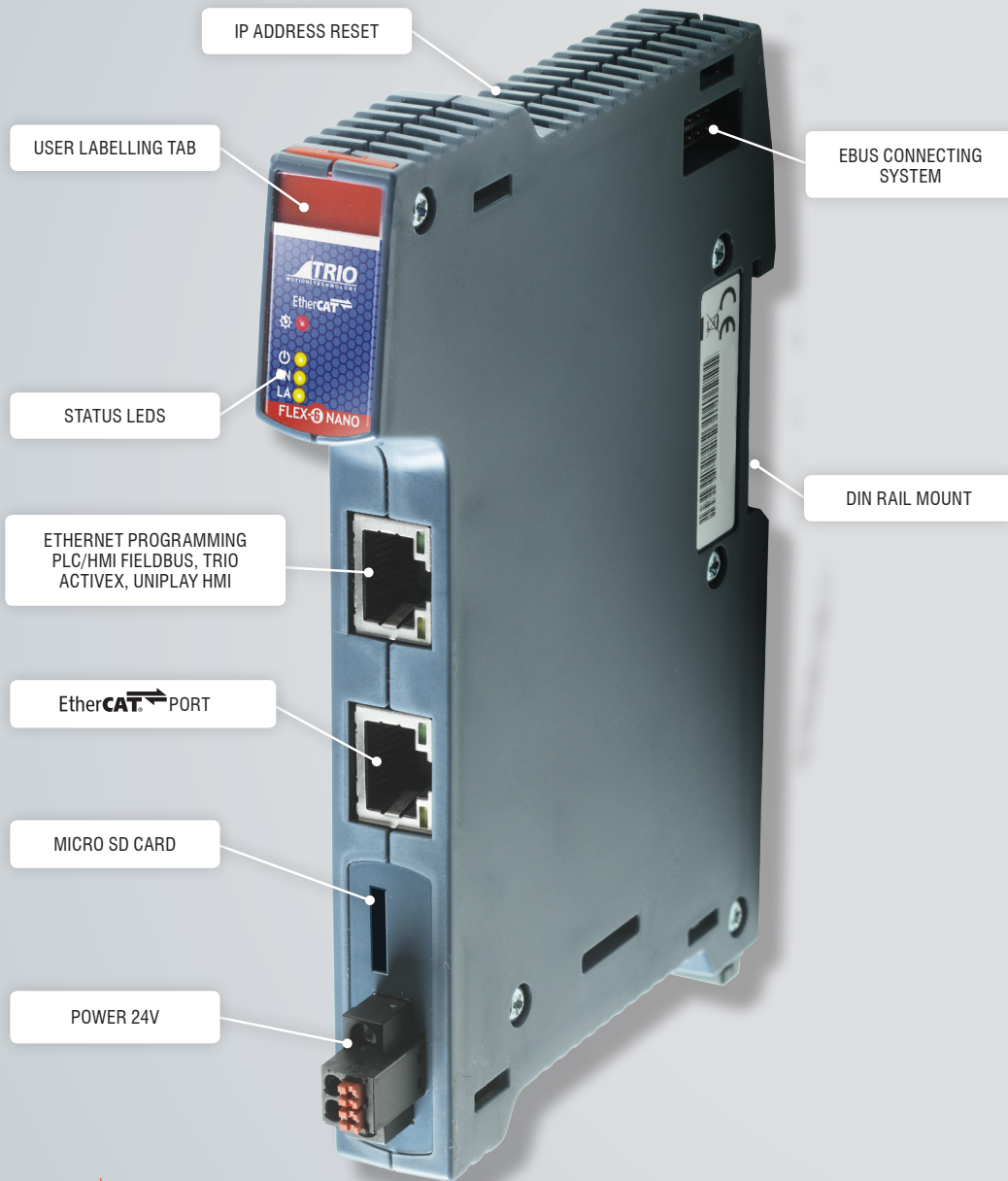
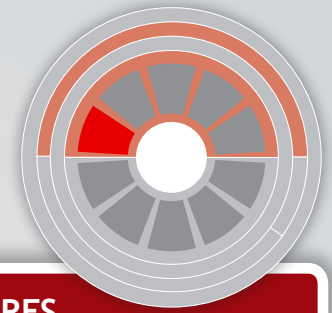

The Flex-6 Nano is a compact, integrated EtherCAT solution offering up to 64 Axes of motion. The on-board memory can be boosted to 32 GByte with the addition of a micro SD card.

The Flex-6 Nano "plugs" straight into our Flexslice System removing the need for the EtherCAT coupler (P366).

Trio's Flexslice input/output system modules provide a robust, high speed and flexible solution for both motion control and general automation. EtherCAT cycle times down to 125µsecs are supported and the bus coupler uses EBUS technology to bring all the sub-modules on to the EtherCAT network with no degradation in performance.

The Flexslice system makes available a selection of digital and analogue I/O terminals as well as motion modules with pulse + direction outputs designed for precise positioning of stepper and servo motors via suitable drive technology.

The digital I/O modules have high-speed functionality. In addition, analogue modules and axis modules may be fitted to make a superbly tailored system that can be placed remotely from the master if needed.

All Flexslice modules support automatic addressing with the master to automatically detect and configure the modules on startup. The bus coupler can support up to 16 input/output modules which have a positive mechanical lock and bus connector, making a reliable EBUS connection through the backplane. The complete assembly can be DIN rail mounted.

FEATURES

- ★ Up to 64 EtherCAT Digital Drive Axes
- ★ EtherCAT Cycle Times Down to 125 µsec
- ★ 1 GHz i.MX7 Dual ARM Cortex A7 Core Processor
- ★ 128 Mbyte DDR3 Memory
- ★ 128 Mbyte Fast Serial NOR Flash
- ★ Real Time Clock
- ★ Built in Ethercat Coupler for Direct Access to Trio's Flexslice Slaves
- ★ Cycle Time as Low as 125us
- ★ Field programmable with *Motion Perfect*
- ★ High Performance, Flexible Topology and Simple Configuration
- ★ Bus Cycle Time Synchronised with *Motion Coordinator* Servo Period
- ★ Ethercat Protocol to Individual Modules Using the EBUS System
- ★ I/O Functions Tightly Synchronised to Motion Using Ethercat Distributed Clocks
- ★ Practical Push-In Connector Options – No Break Outs Required
- ★ Clip-Together Design With 'Quick Release' Locks For Mechanical Integrity
- ★ RoHS, CE and UL Approved

EtherCAT®

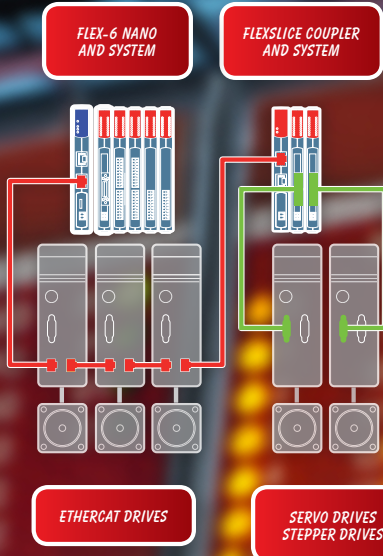

- EXPANSION:**
- P366 Flexslice EtherCAT Coupler
 - P371 Flexslice 16-Out PNP
 - P372 Flexslice 16-In PNP
 - P375 Flexslice Flex 3-Axis
 - P376 Flexslice 16-Out NPN
 - P377 Flexslice 16-In NPN
 - P378 Flexslice 8 Analogue Outputs
 - P379 Flexslice 8 Analogue Inputs
 - P367 Flexslice Thermocouple *
 - P373 Flexslice 8-In 8-Out*
 - P374 Flexslice Analogue 2 Servo Axes*
- * Coming soon

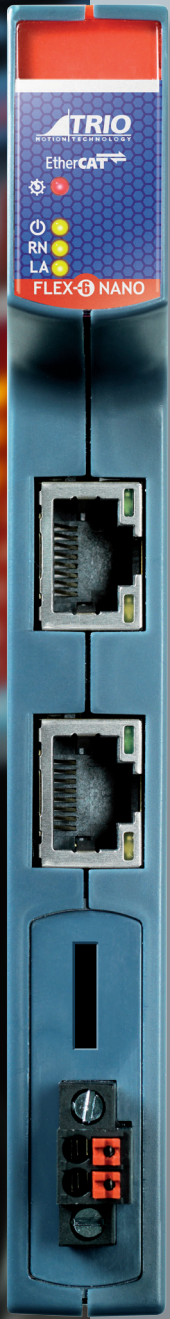

To help with identification, each Flexslice module incorporates a handy removable tab that can be written on. It simply slides in and out of a slot at the top of each module.



The Micro SD Card port allows the memory to be expanded to up to 32 GByte.



The Flex-6 Nano plugs straight into the Flexslice System via the EtherCAT connector allowing expansion of the system.

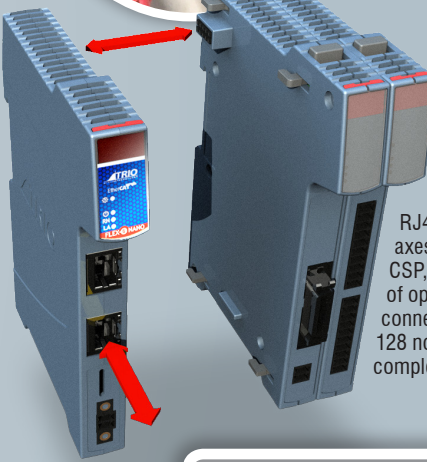

EtherCAT slave nodes are connected via the Flexslice EtherCAT and the EtherCAT connector (lower RJ45 socket). Up to 64 axes are supported using CSP, CSV and CST modes of operation. Total slave connections can be up to 128 nodes including I/O and complex devices.

- HIGHLIGHTS:**
- Multitasking Operating System
 - Comprehensive Motion Library
 - TrioBasic Motion Language
 - IEC611-3 Programming
 - UNIPLAY HMI Support
 - Robotic Functions
 - Multi-protocol Communications Support

PRODUCT CODES:

P600	Flex-6 Nano	2 Axes
P601	Flex-6 Nano	4 Axes
P602	Flex-6 Nano	8 Axes
P603	Flex-6 Nano	16 Axes
P604	Flex-6 Nano	32 Axes
P605	Flex-6 Nano	64 Axes

