



TRIO MOTION TECHNOLOGY PRODUCT BROCHURE

MOTION COORDINATOR | I/O DEVICES | HMI | SOFTWARE



THE MOTION SPECIALIST

ABOUT TRIO

ABOUT TRIO 2

SOFTWARE 4

<i>Motion Perfect v4</i>	5
Free Support Software	8
TrioBASIC	9
IEC 61131-3	10
Robot Programming System	11

PRODUCTS 13

FLEX-6 NANO	14
MC6N-ECAT	16
MC664-X	18
MC664	18
MC664 / MC664-X Expansion	20
PC-MCAT 64	22
PC-MCAT S	23
Flexslice System	24
UNIPLAY HMI	28
MC403	30
MC403-Z	30
MC405	32
MC508	34
Euro404	36
Euro408	36
MC4N-RTEX	38
CAN I/O Modules	40
Custom Products	42

THE TRIO NETWORK 43

Trio Motion Technology provides a specialised source of high performance motion control technology. We manufacture flexible and economical solutions for motion control applications, enabling control of complex high speed automation and machine control in most industries throughout the world.

Trio Motion Technology has been manufacturing high-quality motion controllers branded "*Motion Coordinators*" since 1987 and has a comprehensive range that allows seamless control of 1 to 128 axes of servo motors, stepper motors, piezo motors or hydraulic systems. With over 165,000 *Motion Coordinators* in the field, Trio products can be found in virtually every servo and stepper application.

Our Approach

Trio does not sell servo drives or motors; preferring instead to provide the interfaces required to enable you to choose motors and drives to best suit your requirements. With Trio support offices in Tewkesbury (UK), Pittsburgh (USA), Pune (India) and Shanghai (China), Trio Motion Technology supplies its entire product range worldwide via a network of fully supported distributors.

Motion Coordinators

Trio Motion Technology's range of *Motion Coordinators*, Expansion Modules, I/O modules, EtherCAT devices and HMI's are designed to enable the control of industrial machines with the minimum of external components. In many applications, Trio's range can be combined to build a control system capable of driving a multi axis machine and all its auxiliary equipment. Information on all our products may be found on our website at www.triomotion.com.

Trio's Software

Trio has developed powerful software tools for use with every *Motion Coordinator*. These tools provide all the features necessary for setup, programming, cam profile generation, and CAD 2D path conversion.

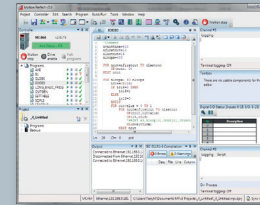

All *Motion Coordinators* feature Trio's multi-tasking BASIC programming language. In addition IEC 61131-3 programming techniques can be used. G-Code and HPGL files can be processed on the controller using example programs available from Trio. This gives the option to use the most suitable language for your needs.

An Expert in Motion

Trio has a dedicated in-house research and development team that designs motion control products as solutions for customer applications. Over the years we have introduced many innovations into the market.



Because of Trio's rich history of producing innovative motion products, it has become a source for other companies wishing to incorporate motion control technology into their products. Major automation companies either use Trio standard products as their control line, or have worked with Trio to design custom products exclusively for them.

Manufacture

Our manufacturing is done by carefully selected subcontractors, allowing us to quickly ramp up production to fulfil large orders. Trio purchases key component parts and provides kits to our subcontractors allowing us to control the quality of the components used. We aim to deliver most orders from stock. All our products are tested to international standards and the company holds ISO9001:2015 quality approval certification.



Training

We offer a 2-day introductory course based at any of our four main offices, designed to provide an overview of the *Motion Coordinator* product range and to give an introduction to programming using TrioBASIC.



The course is based upon practical worked examples of each topic covered to enable the attendees to gain some valuable hands-on experience of using *Motion Perfect* to develop applications.

For experienced programmers and customers requiring specialised or more advanced training we can tailor a course to suit your specific needs.

Whether you are currently using our products or considering them for the first time we want you to gain the most from selecting Trio as your motion control provider.

Applications

- * Assembly
- * Bending
- * Battery Manufacturing
- * Carton Folding

- * Coil wrapping
- * Converting
- * Cut to Length
- * Entertainment

- * Flow Wrapping
- * Glue Laying
- * Grinding
- * Handling

- * Inspection
- * Labelling
- * Packaging
- * Printing

- * Retrofits
- * Robotics
- * Spark Erosion
- * Stamping

- * Testing
- * Tufting
- * Welding



SOFTWARE

Powerful Software Tools

Trio has developed powerful software tools for use with every *Motion Coordinator*. These tools provide all the features necessary for setup, programming, cam profile generation, and CAD 2D path conversion to ensure minimum development time.

Motion Perfect

A PC running the Microsoft Windows™ operating system is used to develop and test the application programs which co-ordinate all the required motion and machine functions using Trio's *Motion Perfect* software. *Motion Perfect* provides all the editing and debugging functionality needed to write and debug applications written in TrioBASIC and all supported IEC languages, with direct links to HMI pages. The completed application does not require the PC in order to run.

Multi-Tasking BASIC

TrioBASIC is a multi-tasking programming language used by all the Trio *Motion Coordinator* range. The syntax is similar to that of other BASIC family languages. Multiple programs can be constructed and run simultaneously to make programming of complex applications much easier.

IEC 61131-3

Motion Coordinators can also harness the power of IEC 61131-3, the vendor-independent standardised programming language for industrial automation. The standard is already well established in Europe and is rapidly gaining popularity in North America and Asia as the programming language of preference for industrial control.

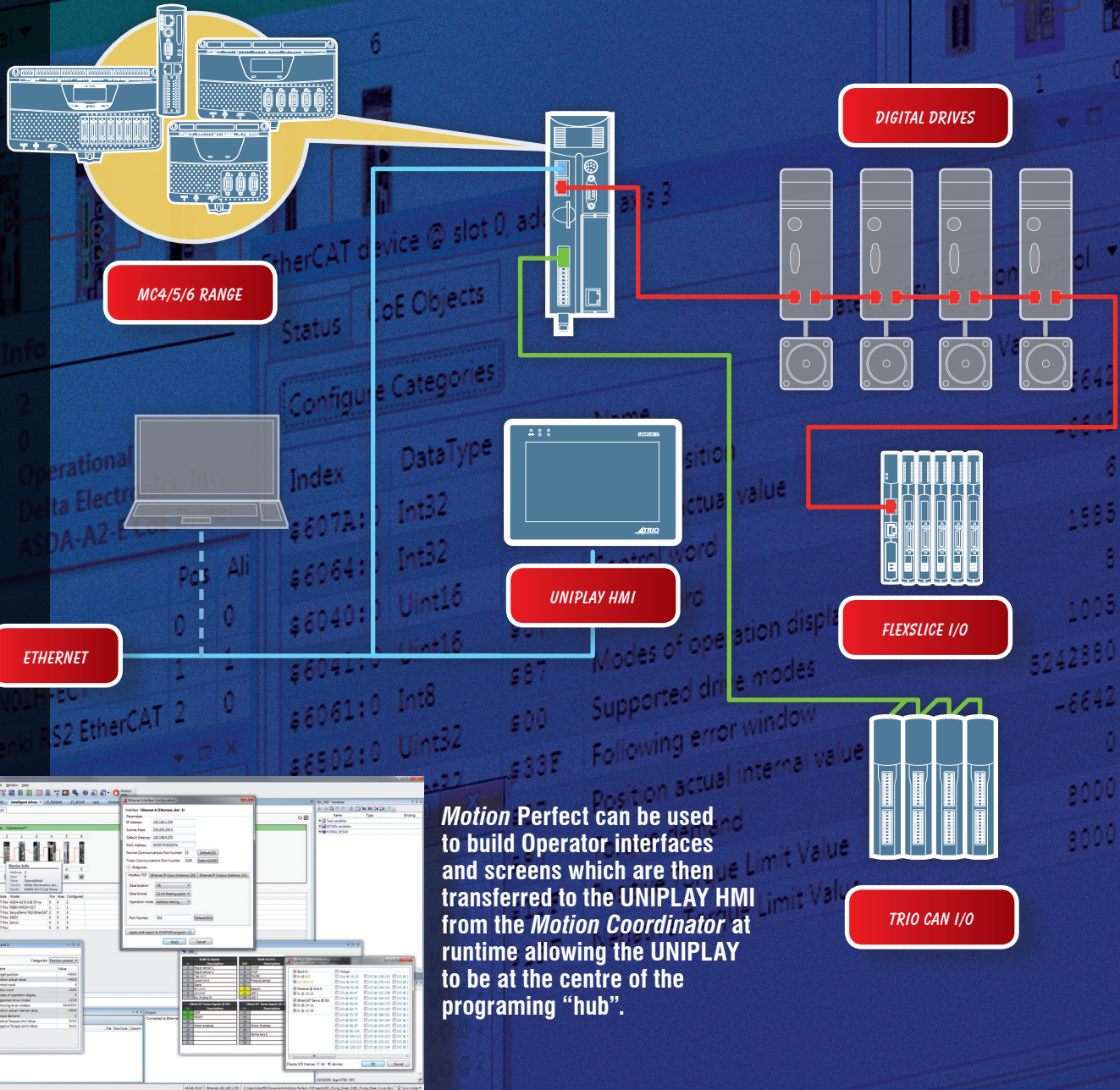

Motion Perfect can be used to build Operator interfaces and screens which are then transferred to the UNIPLAY HMI from the *Motion Coordinator* at runtime allowing the UNIPLAY to be at the centre of the programming "hub".

Motion Perfect v4

FEATURES

- ★ **Clear Connection Modes...** *Motion Perfect* can connect to the *Motion Coordinator* MC4 range and above in Direct, Tool or Synchronous mode, allowing connection at a level that is appropriate to the operations needed.
- ★ **EtherCAT drive support...** View and control the network state, see individual drive status information, read and set CoE objects in the remote drive.
- ★ **Panasonic RTEX Drive Support...** User Interface supports large numbers of drives with greater responsiveness and a New STARTUP file generation process to improve usability.
- ★ **Tree view of *Motion Coordinator* and Project...** See all the controller and project information in one place, via a familiar intuitive display.
- ★ **Window docking...** Allows the user even more flexibility in how the *Motion Perfect* v4 desktop is laid out.
- ★ **Program editor...** The TrioBASIC editor appears in a tabbed layout and includes enhanced breakpoint handling, bookmarks, auto commenting and scope checking.
- ★ **Support for IEC 61131-3 included...** The program editor can be used to create and edit IEC 61131-3 programs in Structured Text, Function Block, Sequential Function Chart and Ladder.
- ★ **Enhanced Axis Parameter display...** Choose which parameter groups to display and which parameters to see live in a continuously updated window.
- ★ **Data viewers...** The VR and TABLE viewers can be set to display non-contiguous data ranges and with auto-updating enabled will provide a live display of the values.
- ★ **Real-time-clock synchronisation...** View the contents of the *Motion Coordinator's* real-time clock (where fitted) and synchronise it with the PC clock at the touch of a button.
- ★ **STARTUP generation...** Improved wizard for generation and modification of STARTUP.BAS.
- ★ **Project resolution dialogues...** When connecting to the *Motion Coordinator* a completely new set of windows will guide you through the process of synchronising the controller's project with the copy on the PC.
- ★ **Support for multiple controllers...** View any number of controllers using the solution manager from one instance of *Motion Perfect* v4
- ★ **Fully integrated HMI support...** Design a complete graphical HMI interface within *Motion Perfect* v4 where buttons and fields can link to any system parameter or command.
- ★ **Oscilloscope...** Up to 32 channels can be linked to axis and system parameters. X/Y display mode for interpolated motion in 2D.
- ★ **3D Scope display mode...** Helps with visualisation of XYZ paths.
- ★ **Language Support...** Support for Chinese language
- ★ **3D machine visualisation tool...** Take a 3D solid model of the working parts of the machine motion and animate it to see a simulation controlled from the motion program.

Motion Perfect v4 is a Microsoft Windows™ based application for the PC, designed to be used in conjunction with Trio Motion Technology's *Motion Coordinator* MC4 and above range of multi-tasking motion controllers.

Motion Perfect v4 has been developed using the latest .NET and WPF technologies from Microsoft. Designed from the ground up to make setup, diagnostics, commissioning and using our range of *Motion Coordinators* even more straight-forward.

It provides the user with an easy to understand Windows based interface for rapid application development, controller configuration and monitoring of controller processes.

Motion Perfect v4 comes with the MC400 Simulator and Uniplay HMI Simulator program which allows offline programming.

Motion Perfect v4 is available as a **FREE** download from the Trio website: www.triomotion.com

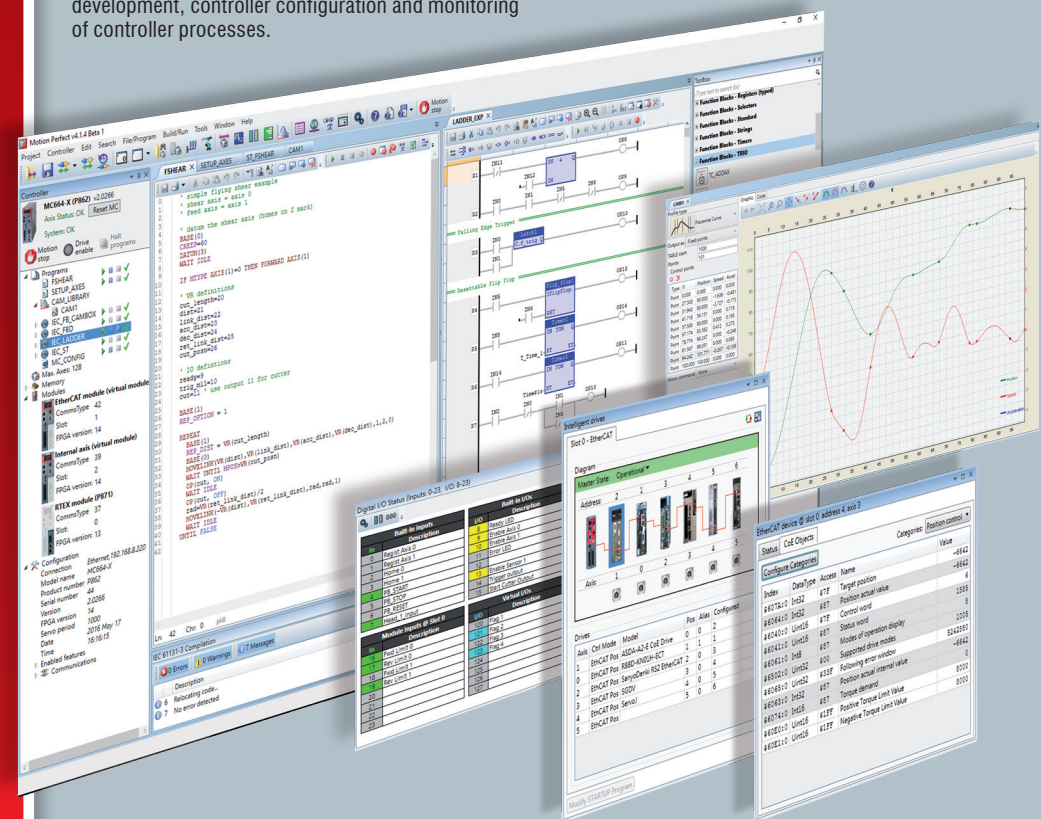

Motion Perfect v4 Free Download

Motion Perfect Projects

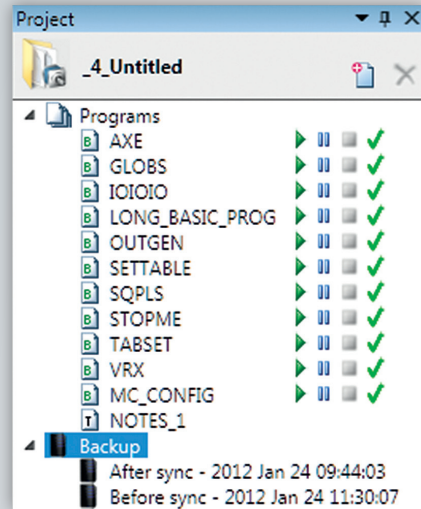

One of the keys to using *Motion Perfect v4* is its concept of a "Project". The project aids the application design and development process, by providing a copy of the multiple controller programs, parameters and data required for a single motion application, all stored in one folder.

Once the user has defined a project, *Motion Perfect v4* works behind the scenes automatically maintaining consistency between the programs on the controller and the files on the PC.

When creating or editing programs on the controller they are automatically duplicated on the PC which means you do not have to worry about loading or saving programs and you can be confident that next time you connect to a Coordinator you will have the correct information on your PC.

Project Manager

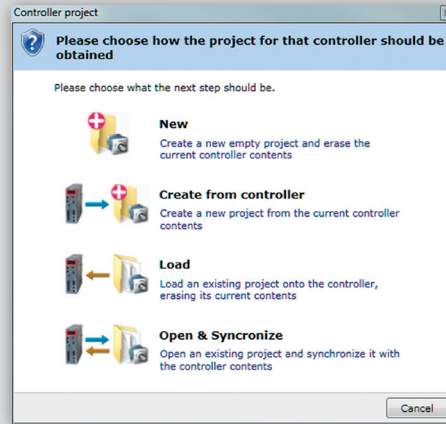

The multi-tasking capability of *Motion Coordinators* means there will be a number of different program files to make an application. In order to keep track of these multiple files and their associated data, a major component of the *Motion Perfect v4* environment is the project manager.

- Load and Save multiple programs as a single named project
- Simultaneous saving of program files to both the PC and the *Motion Coordinator*
- Verify that the contents of a Coordinator match the project file on disk
- Load and Save controller variables and table memory to disk
- Automatically generate Coordinator "Startup" configuration files
- Include BASIC, HMI and IEC 61131-3 programs in the same project

Digital I/O Status

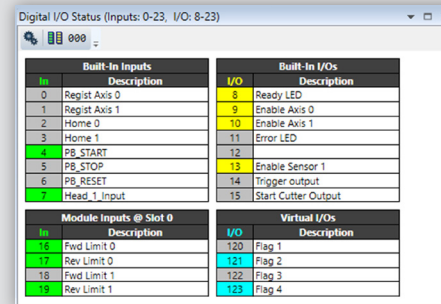

- Display status of all I/O Channels simultaneously
- Automatically configures to support available I/O
- Set outputs with a mouse click
- I/O's can be named and saved in a Project

Project Encryptor

The Project Encryptor is a utility that enables a programmer's intellectual property to be licenced to individual *Motion Coordinators*. Once encrypted the program is safe to distribute and can only be loaded to a controller with a correct key, which is unique to both the controller serial number or distributor code and source project.

Axis Parameter Screen

- Spreadsheet style interface to monitor and set axis parameters
- Automatically updates real time parameters
- Support for all axis types (including virtual axes)
- Enhanced user configured axis display

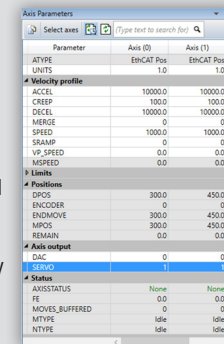

Drive Setup / Parameterisation

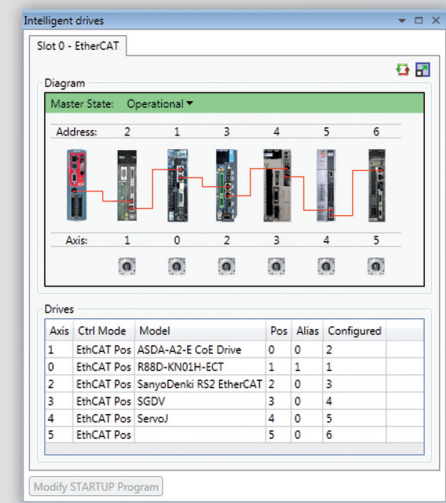

When using fieldbus axes connected to a MC4N, MC664 or MC464, *Motion Perfect v4* can access and display bus status and node specific information.

- Display and control the network state
- Diagram view of the fieldbus network
- Double click on any drive or IO node and view the node status
- Select and view drive parameters. (CoE and RTEK)
- Build a STARTUP file to configure the drives (RTEK only)

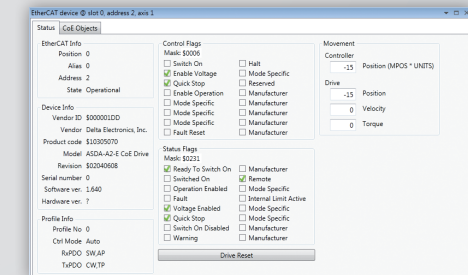

Motion Perfect v4

HMI Editor / Uniplay

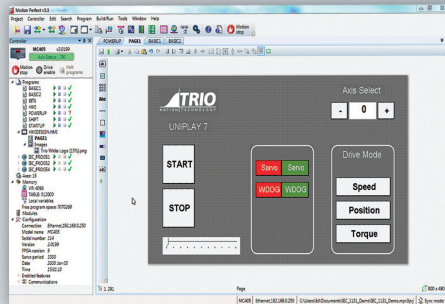

Trio's unique UNIPLAY HMI system keeps all the application programming in one place. No need for a separate HMI programming tool. *Motion Perfect v4* comes with a built in visual editor for the Trio UNIPLAY HMIs.

- Full function visual editor
- Select and draw objects directly to the screen
- Button, text box, progress bar, combo box and many other object types
- Link object attributes to BASIC program variables
- Supports integer, floating point and text string variables
- Simulate the HMI on your PC

3D Scope

The oscilloscope has a new 3D display mode. Configure the sample rate, trace thickness and colour. Pan, zoom and rotate in 3D in real-time.

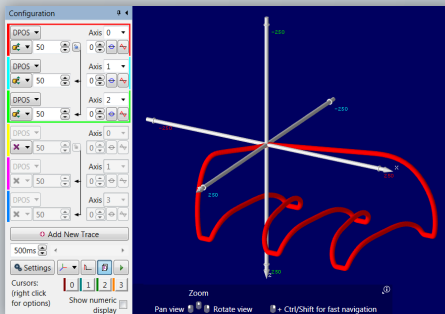

Basic Program Editor

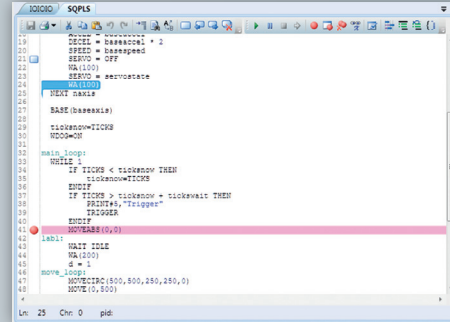

- Simultaneously edits the controller program and a copy on disk - programs do not need to be downloaded after editing
- Windows style editor with Cut, Copy & Paste - information may be pasted between programs
- Edit multiple programs simultaneously
- Find & Replace
- Jump directly to any line number or program label
- View and edit programs while they are running
- Bookmark lines for easy access
- Offline editing with advanced MC400 simulator
- Immediate line tokenisation
- Context sensitive help
- Autocomplete suggestions and command line help menus
- Keyword assisted and parameter help
- Auto-formatting, colour-coded syntax to make editing and debugging easier

CamGen

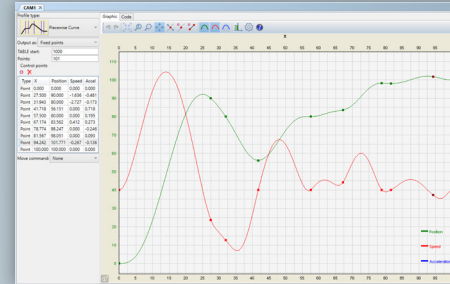

Define and generate cam tables using this interactive graphical cam designer. Commonly used cam shapes are pre-built into the CAM library software.

The required dimensions and offsets can be entered and the resulting cam shape is immediately shown as graphs of position, speed and acceleration. Data can be output as a cam table formula or as **FLEXLINK** parameters.

Alternatively, cam shapes can be built up using the interactive "Piecewise Curve" feature. Enter your XY points and see the resulting cam shapes. Points can be adjusted by dragging points on the graph, giving a truly interactive experience and saving time compared to using trial and error techniques.

The resulting cam tables are ready to be copied and pasted into your programs and used with **CAM** and **CAMBOX** functions.

MC400 Simulator

If for any reason a *Motion Coordinator* is not available, the MC400 Simulator provides a software simulation of Trio Motion Technology's MC4/5/6 range of multi-tasking *Motion Coordinators*.

3D Visualization Tool

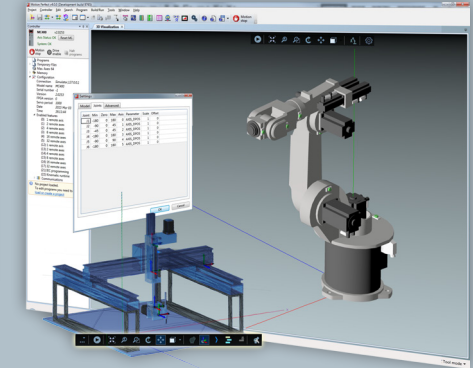

The 3D Visualization tool, available in *Motion Perfect v4*, enables simulation of Machine Motion, using an externally generated 3D model which can be synchronized with the motion program. This tool can simulate realistic movement sequences on a PC in real time.

Motion Perfect Help

Motion Perfect v4 comes with complete help files for TrioBASIC and the IEC programming libraries. Using the search function, or jumping to a help topic via the context sensitive help in the editor, the programmer has access to all the information from Trio's technical programming manuals. The help files are also rich in programming examples for many motion applications.

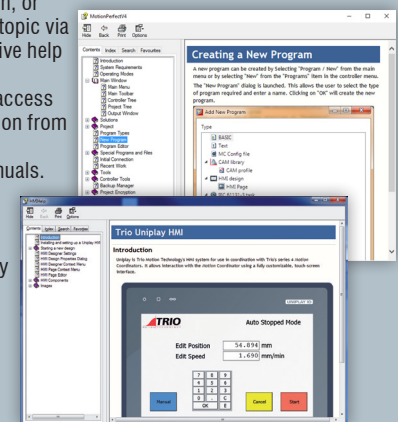

Free Support Software

CAD2Motion

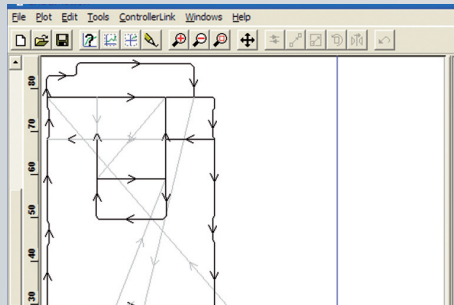

CAD2Motion is a program designed to allow users to translate CAD generated two dimensional motion paths into TrioBASIC programs.

The program allows the user to create motion paths in a CAD package such as AutoCAD and convert them into code executable by a Trio *Motion Coordinator*. Typically the path information will be drawn on a single layer in the CAD package and exported as a DXF file. The DXF file (layer with motion path only) is read into CAD2Motion to create a 2D program to follow the motion path.

The motion path can be manipulated and edited before being saved as a TrioBASIC program file that can be loaded onto a Trio *Motion Coordinator*.

Trio PCMotion

PCMotion is an ActiveX component allowing direct connection to the Trio *Motion Coordinator* from a custom user application. It can be used to control any of the *Motion Coordinator* functionality as well as send text files down to the Coordinator.

PCMotion ActiveX runs a high speed dedicated communications protocol between the user application and the *Motion Coordinator*. It allows simple programming of user 'front end' software that can be "tailored" to the application.

PCMotion ActiveX can be used in any programming language that supports ActiveX (OCX) components such as any of the Microsoft Visual languages (BASIC, C#, C++, etc.), LabView, Delphi, etc.

Autoloader

A compact, self-contained package designed to allow simple distribution of projects written using *Motion Perfect v4*. Simply add the project to the Autoloader folder, edit a script file to provide control of the loading sequence and send to the customer. The Autoloader, complete with project files is small enough to distribute efficiently via email and the end user needs only minimal PC knowledge to complete the loading process.

MCLoader

Trio MCLoader is a Windows ActiveX control which can load projects (produced with *Motion Perfect v4*) and programs onto a Trio *Motion Coordinator*. Communication can be via Ethernet.

TextFileLoader

The TextFileLoader can load files into the *Motion Coordinator's* memory or the SD card. This allows machine files written in text based languages such as G-Code and HPGL to be loaded to the *Motion Coordinator* where they can be parsed and executed by a TrioBASIC program.

The transfer process is optimised to compress the file and reduce transfer times, or it can be set to stream the file into a FIFO buffer on the *Motion Coordinator*. This can help reduce overall machine cycle times when file sizes can be large.

G-Code & HGPL Programming

The Trio MC4 range of *Motion Coordinators* has the ability to save and read text files, operate FIFO buffer files and receive text data such as G-Code and HPGL. This text file handling allows TrioBASIC to process either pre-recorded files or stream information coming in real-time to a serial port or the Ethernet port. String handling functions in the TrioBASIC allow for simple parsing of any text based file.

Example G-Code parsing and dispatching programs can be made available, that can then be used as the basis for a machine development. The examples cover the use of many common codes controlling up to 3 axes. As the examples are all written in TrioBASIC they are fully adaptable by the machine builder or system programmer to suit custom mechanics or special functions.

Similar to G-Code an HGPL parser can also be provided which reads the HGPL sequence line by line. A conversion program takes the HPGL commands like PR (plot relative), AA (arc absolute) and LT (line type) and performs the appropriate motion operation. Machine designers have access to the program and can change the actions performed to suit their application.

This flexible approach ensures that OEMs can maintain control over the machine specification and add differentiators to make them stand out in their market.

TrioBASIC

FEATURES

- ★ Fast BASIC language for easy standalone machine programming
- ★ Fully integrated with Trio's *Motion Perfect* application development software
- ★ Comprehensive motion control functions for multiple axes
- ★ Multi-tasking of multiple programs for improved software structure and maintenance
- ★ Support for traditional servo or stepper axes as well as digital (EtherCAT, RTEX, Sercos, SLM) axes
- ★ A comprehensive set of move types supporting multiple axis coordination as well as simple single axis moves. This includes linear, circular and spherical interpolation as well as cam profiles and software gearboxes
- ★ Real maths (up to 64 bit) including bit operators and variables
- ★ Support for hardware position capture
- ★ Support for high speed outputs

TrioBASIC is a multi-tasking programming language used by the *Trio Motion Coordinator* range. The syntax is similar to that of other BASIC family languages.

A PC with Microsoft Windows™ operating system running Trio's *Motion Perfect* v4 software is used to develop and test the application programs which coordinate all the required motion and machine functions. *Motion Perfect* v4 provides all editing and debugging functionality needed to write and debug applications written in TrioBASIC. The completed application does not require the PC in order to run.

One of the many strengths of TrioBASIC is that a program written for an entry level *Motion Coordinator* can be run, with only minimal modification on the highest performance *Motion Coordinator*. This portability extends even to users requiring upgrades for older *Motion Coordinators* where the core functions of a program written in TrioBASIC over a decade ago will still run on the latest hardware platforms.

Motion Profile Generation

Every *Motion Coordinator* includes a feature-rich Motion Profile Generator. This allows the *Motion Coordinator* to set axis speeds and acceleration as well as accurately control the gearing during linked motion. All motion commands issued by either TrioBASIC or IEC 61131-3 programs run in the same known and repeatable way.

The target axis type, whether analogue servo, stepper or a digital axis, has no effect on the motion profile. This makes programming *Motion Coordinators* very predictable and gives consistent results no matter which programming system or axis type is used.

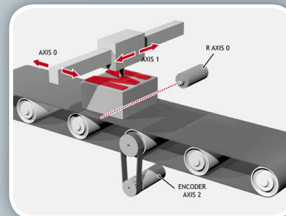

Multi-Tasking

At the heart of the *Motion Coordinator* is an efficient and highly reliable pre-emptive multi-tasking operating system. Application programs and system processes share the processor resources in a deterministic way.

BASIC Language

This familiar, easy-to-use but powerful language, has been the mainstay of motion programming for over three decades. The MC4/5/6 range extends the functionality while keeping compatibility with previous versions of TrioBASIC.

Motion

Every *Motion Coordinator* comes with an extensive library of Motion Functions. Intuitive commands like **MOVE**, **MOVEABS**, **SPEED** etc. allow first time users to quickly generate fully functioning motion programs.

Linked Motion

One of the strengths of the TrioBASIC motion language is the provision of accurate and repeatable functions for linking an axis to a master. The powerful set of commands gives life to a huge number of applications, such as flying shear, flow wrapper and conveyor synchronisation. **MOVELINK**, **CAMBOX** and **FLEXLINK** commands cover 99% of linked motion types.

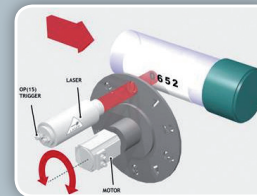

Look-Ahead

Multi-axis interpolation often uses CAD/CAM data as the motion source. The Look-Ahead functions allow data from polylines to be buffered and handled in an intelligent way. Both constant speed for glue-laying, or corner speed control for cutting, allow an XY motion system to be tailored precisely to need.

3D Motion

In addition to linear, circular and helical interpolated moves, the *Motion Coordinator* MC4/5/6 range supports spherical moves and plane rotation in 3 dimensions. 64 bit mathematics produces a dramatic improvement in accuracy and resolution when generating curves.

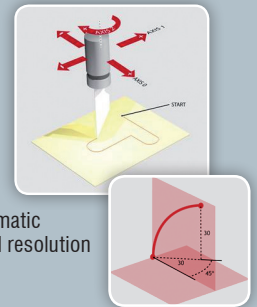

Robotics

The MC4/5/6 range opens up a new world of robotics and frame transformations. 2 and 3 axis Delta systems are programmed in familiar Cartesian coordinates while the complex axis position calculations are taken care of by the *Motion Coordinator*. Scara robots with up to 4 axes and articulated robots with up to 6 axes are also supported.

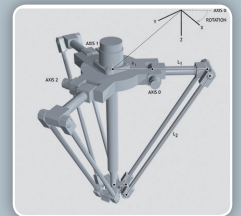

- ★ Delta
- ★ Parallel Link
- ★ Scara
- ★ Cartesian
- ★ Anthropomorphic
- ★ Single Belt 2 Axis
- ★ Custom Kinematic Transformations

Communications

The speed and power of the BASIC language can be used to create protocol engines for RS232, RS485 and CANbus communications. Alternatively the growing number of built-in protocols can be configured by simply running the appropriate BASIC function.

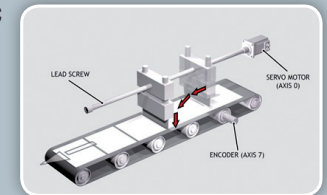

IEC 61131-3

FEATURES

- ★ Standard language can be used by any programmer who is already familiar with IEC 61131-3
- ★ Choice of graphical or textual programming while attaining consistent results
- ★ Visual interactive debugging information
- ★ Real-time program execution
- ★ Powerful and familiar Trio Motion function block library
- ★ Program editor is built-in to *Motion Perfect v4*
- ★ Multi-tasking operation with user selectable priorities

With IEC 61131-3, programming of PLCs, distributed control systems, and motion controllers from different manufacturers is more manageable. IEC 61131-3 is the third part of the open international standard IEC 61131 for programmable logic controllers, first published in 1993 by the IEC then later revised in 2003.

Trio's latest MC4/5/6 range of controllers support Ladder Diagram (LD), Function Block Diagram (FBD), Sequential Function Chart (SFC), and Structured Text (ST) programming methods in addition to TrioBASIC. Trio controllers utilize a runtime IEC kernel with added motion and parameter functions like cams, gearing, and interpolated motion. Machine control projects can now be programmed to best meet the needs of the application in a simple but powerful environment.

With the addition of IEC 61131-3 programming, Trio controllers are now equipped to be a more powerful motion and machine control system. The Trio MC4/5/6 range allows multiple programs to run concurrently, eg. ST, LD and TrioBASIC, thus handling I/O and motion most efficiently.

IEC61131-3 is **FREE** on all MC4/5/6 *Motion Coordinators*. A registration code to enable the feature can be obtained via Trio Distributor.

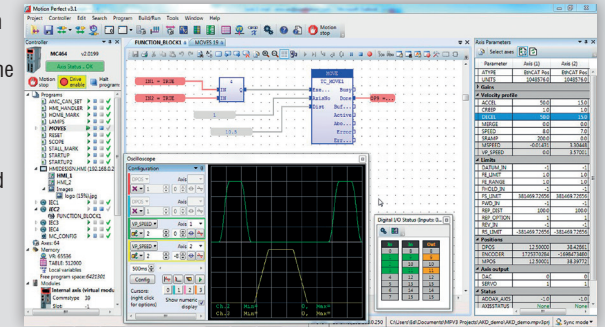

Function Block Diagram (FBD)

The FBD editor is a powerful graphic tool to edit and manage FB diagrams according to the IEC 61131-3 standard. The function block concept is one of the most important features of the standard for supporting hierarchical software design. User functions blocks can be developed and then re-used in higher level programs.

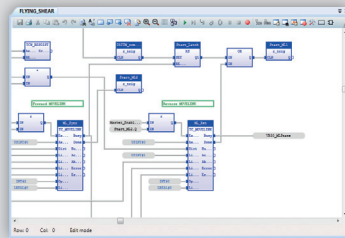

The FBD editor supports advanced graphic features such as drag and drop, object resizing and connection line routing features, so that you can rapidly and freely arrange the elements of your diagram.

Ladder Diagram (LD)

The LD editor is a powerful graphical tool that enables you to enter and manage Ladder Diagrams according to the IEC 61131-3 standard. The editor enables quick input using a keyboard, and it supports advanced graphic features such as drag and drop.

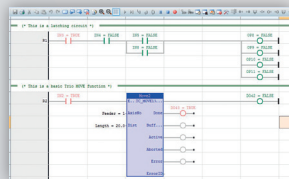

LD is probably the most widely recognised of the four supported methods because of its use in PLCs and its analogy to real world circuits. Programming in LD is best suited to applications where mostly binary variables are required and the interlocking and sequencing of digital I/O points is the primary control requirement.

Structured Text (ST)

The ST editor is a dedicated editor supporting the Structured Text language of the IEC 61131-3 standard and has the following advanced features:

- Full syntax colouring
- "Intellisense" pop-up with Auto-completion
- Drag and drop of objects from toolbox
- Variable type and size assist
- View variable value in source code
- Tool tip with variable or function information

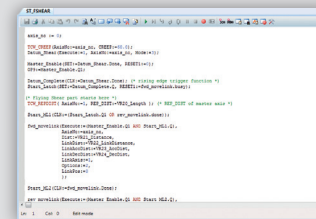

Sequential Function Chart (SFC)

The SFC editor is a powerful graphical tool that enables you to enter and manage Sequential Function Chart programs according to the IEC 61131-3 standard.

The editor supports advanced graphic features such as drag and drop, so that you can rapidly and freely arrange the elements of your diagram. It also supports automatic chart formatting when inserting or deleting items and thus enables quick input using a keyboard.

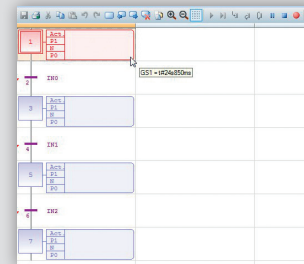

Toolbox & variable definition

Motion Perfect v4 includes a toolbox with a set of IEC 61131-3 standard functions that can be included in all of the supported methods. Functions are simply dragged into the graphical or text editor window to become part of the program.

An interactive program variable definition window helps to keep track of all local and global variables in use. Variables can be bound to the *Motion Coordinator's* inputs, outputs, VR and TABLE data. Use of these "super-global" variables allows the IEC programs to interact with programs written in BASIC and with the Uniplay HMI.

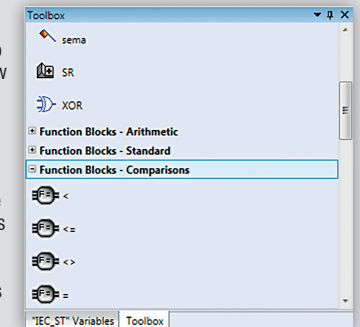

Motion Library

A library of all the motion functions in the *Motion Coordinator* is included with *Motion Perfect v4*. The motion library is in the toolbox so that functions like **MOVE**, **MOVEABS**, **CAMBOX** etc. are dragged into the program in the same way as the standard IEC functions. Motion functions in the IEC language run in axes in exactly the same way as they do from TrioBASIC.

The motion functions are powerful, well-structured and easy to learn. The consistent approach to motion within the *Motion Coordinator* means that programmers familiar with TrioBASIC have the added advantage that they can immediately recognise and start to use the functions.



Robot Programming System

Overview

The Trio Robot Programming System (TrioRPS) is a sophisticated package of tools and software that can be adapted to different robot manufacturers requirements. The RPS allows users the choice of using a programming pendant for simple jobs or stepping up to use a laptop PC for more complex jobs. Many applications can use a mix of both to reduce programming time and optimise productivity.

The Robot Programming System components include:

- ★ A high level robot programming language building on the fast effective multi-tasking TrioBASIC.
- ★ Kinematics transformations package configurable for the majority of robot mechanism types.
- ★ Robot visualization tool in *Motion Perfect v4*.
- ★ Pendant and teach programming system. This allows programs, robot tools and points to be built, edited and proven in an easy to use way.
- ★ A special robot tool within “*Motion Perfect v4*” for robot configuration, editing points, frames and tools. Complex programs may also be edited inside MPv4.

The Robot Programming System can be run on a MC4xx series and above Trio *Motion Coordinator*. Trio recommends: MC4N, MC664, MC508, Flex-6 Nano or PC-MCAT 64.

You make the ROBOT...

We make the
**ROBOTIC
PROGRAMMING
SYSTEM**

TrioBASIC-R

Trio's flexible multi-tasking BASIC is widely used for rapid development of industrial motion applications. TrioBASIC-R (Robotics) adds:

- **TARGET** Position data types
- Programming in world, robot and user frames
- **MOVEJ, MOVEL** and **MOVEC** Robotic move types with definition of move, target, speed, precision, tool and object frame in a single instruction line
- **OBJECT _ FRAME** and **ROBOT _ FRAME** commands
- Supervisor mode programs definable by robot builder allow checking and flagging of singularities, incorrect robot configurations and paths during execution
- Up to 32 tools definable with **TOOL _ OFFSET** tools can be switched in real time to allow use of an auto tool exchanger

RPS Kinematics

The RPS kinematics package covers most of the commonly used mechanism types and can easily be extended for new types. Delta, SCARA plus 5DOF and 6DOF anthropomorphic robots can effectively be programmed in XYZ world, tool and user coordinates. This allows users to focus on their application in a user friendly way and not be concerned with the algorithms being performed.

For robots with higher degrees of freedom, the kinematics package allows the orientation of tools to be defined and controlled during moves. This means that as well as placing a tool to a point in space, the direction can also be defined. The mathematics and joint angles are handled in the controller.

RPS 3D Visualisation

The 3D Visualization tool, available in *Motion Perfect v4*, enables simulation of robot and machine motion, using an externally generated 3D model which can be synchronized with the motion program. This tool can simulate and test realistic movement sequences on a PC in real time.

- Import 3D OBJ file into the 3D Visualisation Tool within *Motion Perfect v4* and pan, zoom and rotate while the robot program is running.
- Interrogate each joint and link to find its position in 3D space.

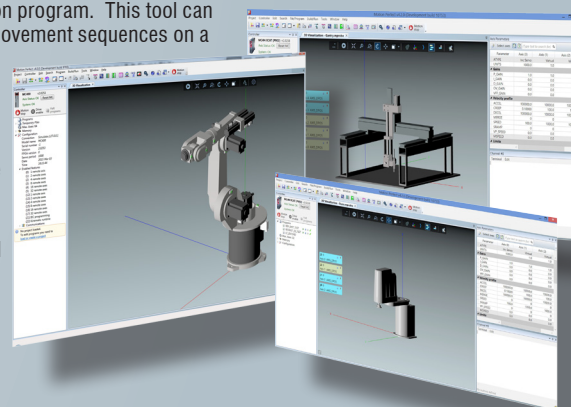

Pendant + Teach Programming System

The Teach Programming System allows programming the robot in a managed and safe environment, using a real or virtual system.

The pendant is based around Trio's UNIPLAY HMI and can be used as a “real” or “virtual” on-screen pendant. The system includes extensive software and preconfigured motion control functions, which permit the controlling of all standard types of robot with reduced development time.

The system allows the user to:

- Configure the robot and drives
- Insert tools and calibrate them
- Insert robot frames and object frames
- Create and edit robot programs
- Debug robot programs adding break points and running it step by step
- Run the robot program in a repeat cycle

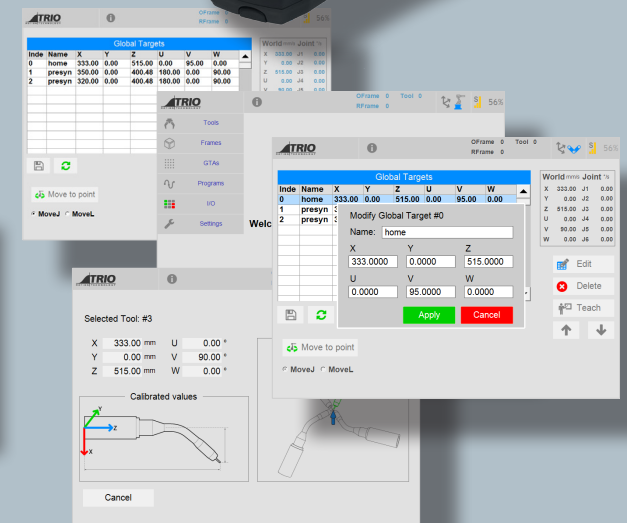

Types of Robot

Cartesian with wrist

A standard Cartesian robot does not require a transformation but a wrist can be added to expand the system up to 6 degrees of freedom. This type of robot is typically used in welding, milling and drawing applications where the tool head translates across an x-y plane while a tool is raised and lowered onto the surface.

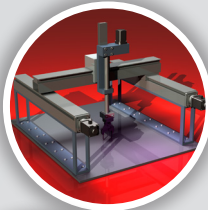

Linear parallel robot

Linear parallel robots use a mechanical configuration so that two of the axes move directly in Cartesian directions. With a large reach and high payload they are often used in palletising applications.

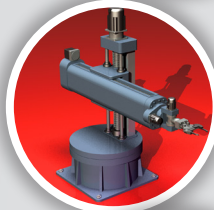

XY single belt

The XY single belt configuration has advantages over a typical XY system of even load sharing between the motors, reduced cable management and often a smaller footprint. The ability to handle a large payload makes them ideal for palletising applications.

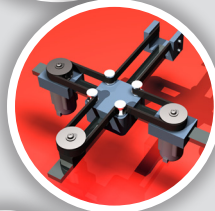

Wire positioning

This application uses from 3 to 6 wires to position the tool in Cartesian X, Y and Z space. Typically this is used in stadiums to position cameras for "fly-overs".

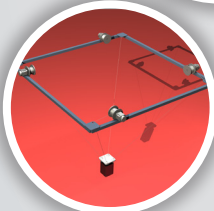

Delta 3 arm

Three arm parallel link robots commonly called delta robots are typically used for high speed pick and place applications.



Parallel arm

The two arm robot can be used for high speed pick and place or assembly as most of the weight is in the base. Mounted horizontally or vertically gives many options for working area and space saving configurations.



Articulated robot

Articulated robots can found in 3 to 6 axes formats which enable them to reach the widest range of positions and orientations. These are commonly seen in welding and paint spraying applications as well as material handling and machine tending.



SCARA

SCARA robots are one of the most flexible designs of robot and are found in many sizes and applications. They can be used in pick and place or assembly applications, but are equally at home in path following applications such as welding or gluing.



The Trio implementation of the SCARA robot allows from 2 axes to a full 6 axes with a 3 degrees of freedom wrist. There are also options to compensate for mechanical parasitic motion as well as different motor configurations.

Supported Features

- * Programming in different coordinate systems
- * Multiple end effectors
- * Vision systems
- * Conveyor Synchronisation
- * Teach systems



You make the ROBOT...
We make the
**ROBOTIC
PROGRAMMING
SYSTEM**

PRODUCTS

The *Motion Coordinator* system is extremely modular, allowing the user to tailor the controller to their specific applications, this also allows the flexibility to incorporate new modules if the need should change, making the system "future proof". Systems may be used with a stand alone program or alternatively commands can be sent from an external computer.

All *Motion Coordinators*, whether panel mount, rack mount, DIN-rail mount or a custom design format, allow digital or analogue I/O expansion with Trio's I/O modules. Special I/O requirements can also be accommodated using the CANopen protocol to control third party I/O modules. The Flexslice System offers fast high performance EtherCAT devices for Trio's range of EtherCAT *Motion Coordinators*.

Trio's UNIPLAY range of operator interfaces provide a robust and functional HMI using the Ethernet network. Third party HMI products, touchscreens, etc. can communicate to the *Motion Coordinator* via the Modbus-RTU serial protocol.

System Set-Up

The MC4/5/6 range includes advanced networking technology for connection to Digital Servos, CANbus and Factory Networks. Access to all parts of the system by network connections allows reduced down-time with automated fault reporting and analysis.

With a MC664 *Motion Coordinator*, it is possible to control a machine with up to 128 axes (64 stepper/servo and 64 virtual), 1024 digital inputs, 1024 digital outputs, 32 analogue inputs and 16 analogue outputs.

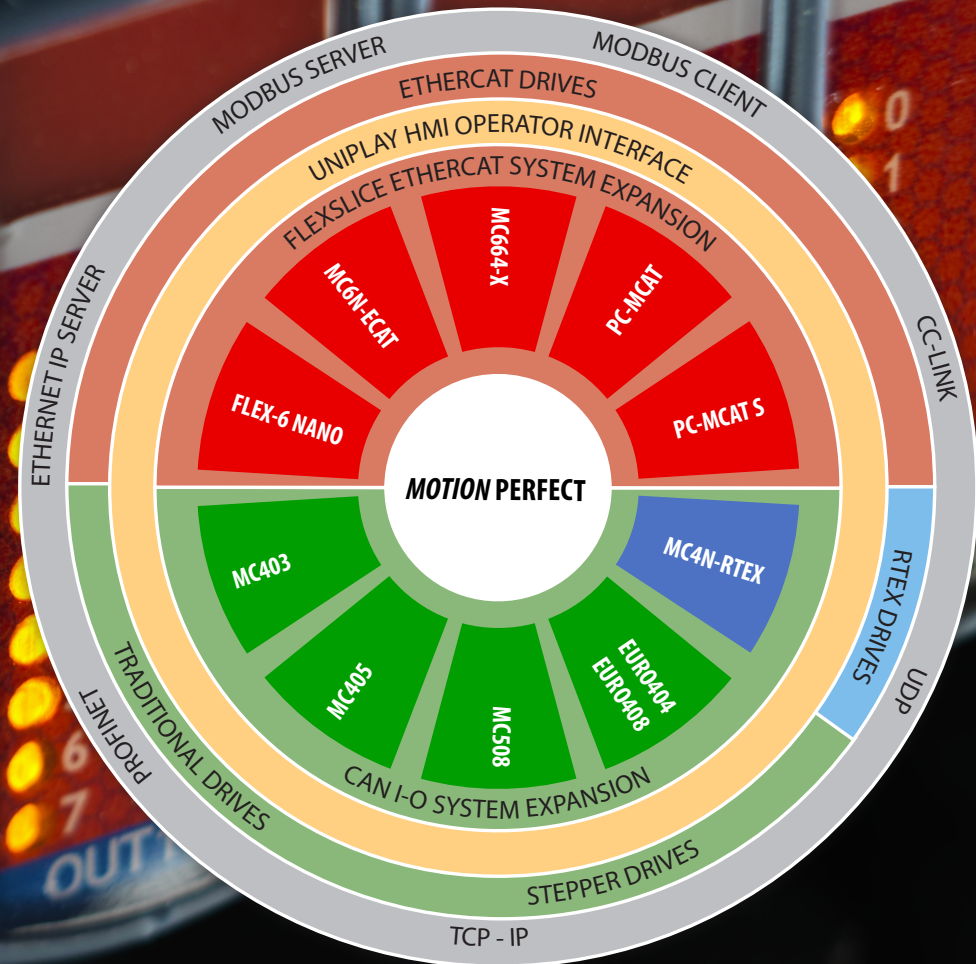
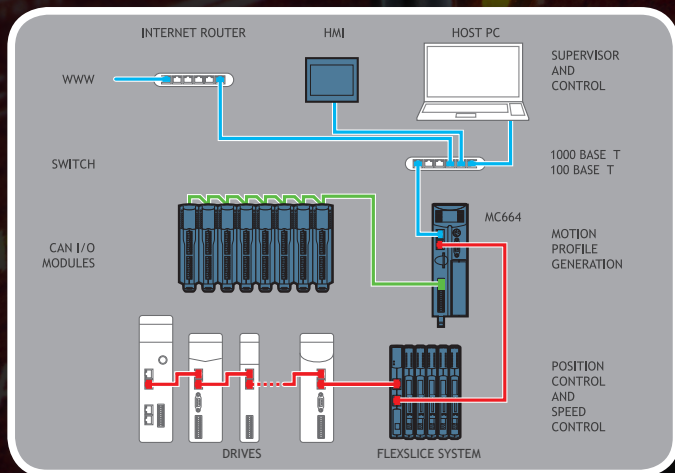

FLEX-6 NANO

64 Axis EtherCAT Motion Coordinator

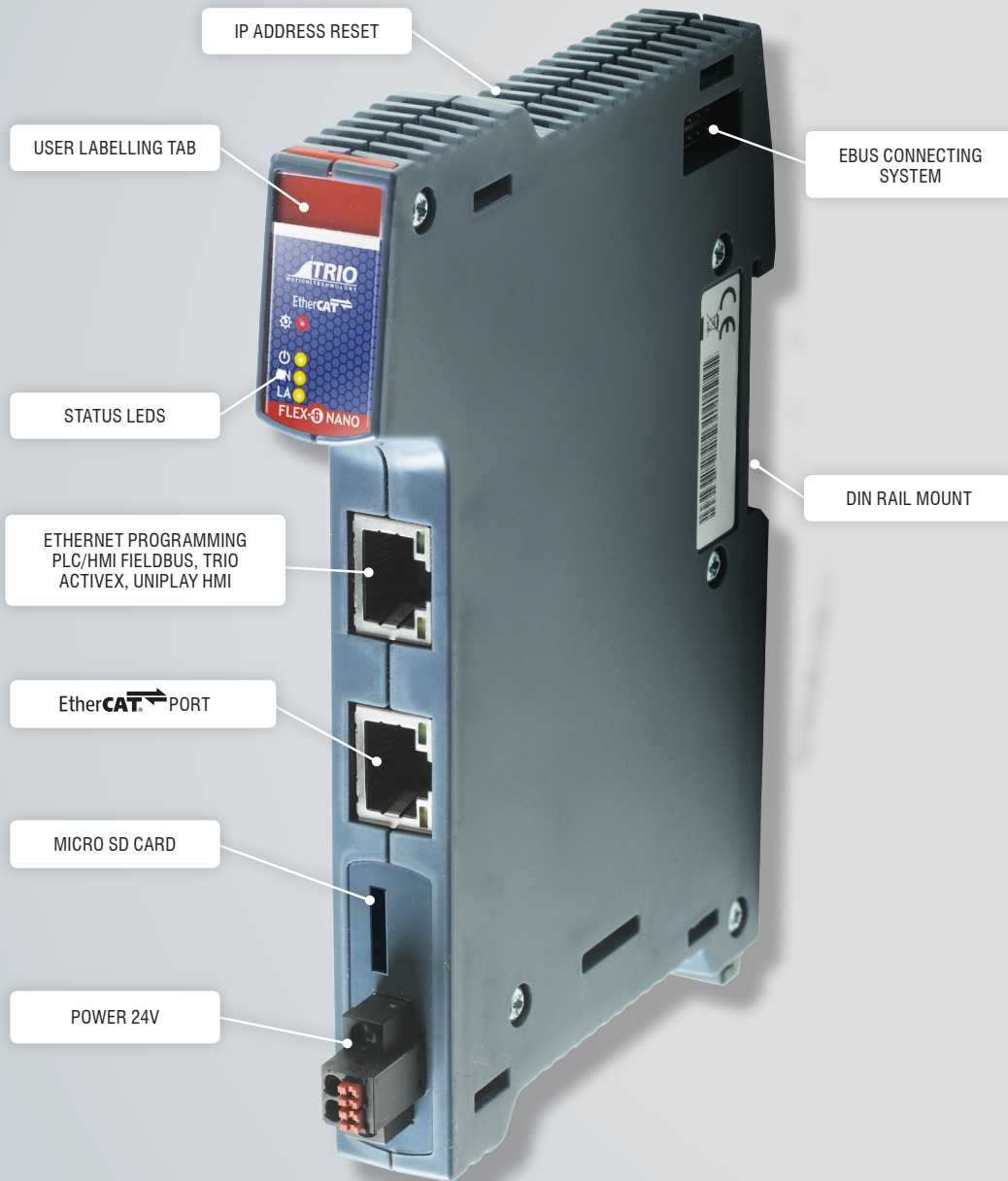
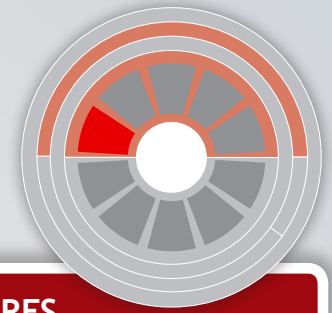

The Flex-6 Nano is a compact, integrated EtherCAT solution offering up to 64 Axes of motion. The on-board memory can be boosted to 32 GByte with the addition of a micro SD card.

The Flex-6 Nano "plugs" straight into our Flexslice System removing the need for the EtherCAT coupler (P366).

Trio's Flexslice input/output system modules provide a robust, high speed and flexible solution for both motion control and general automation. EtherCAT cycle times down to 125µsecs are supported and the bus coupler uses EBUS technology to bring all the sub-modules on to the EtherCAT network with no degradation in performance.

The Flexslice system makes available a selection of digital and analogue I/O terminals as well as motion modules with pulse + direction outputs designed for precise positioning of stepper and servo motors via suitable drive technology.

The digital I/O modules have high-speed functionality. In addition, analogue modules and axis modules may be fitted to make a superbly tailored system that can be placed remotely from the master if needed.

All Flexslice modules support automatic addressing with the master to automatically detect and configure the modules on startup. The bus coupler can support up to 16 input/output modules which have a positive mechanical lock and bus connector, making a reliable EBUS connection through the backplane. The complete assembly can be DIN rail mounted.

FEATURES

- ★ Up to 64 EtherCAT Digital Drive Axes
- ★ EtherCAT Cycle Times Down to 125 µsec
- ★ 1 GHz i.MX7 Dual ARM Cortex A7 Core Processor
- ★ 128 Mbyte DDR3 Memory
- ★ 128 Mbyte Fast Serial NOR Flash
- ★ Real Time Clock
- ★ Built in Ethercat Coupler for Direct Access to Trio's Flexslice Slaves
- ★ Cycle Time as Low as 125us
- ★ Field programmable with *Motion Perfect*
- ★ High Performance, Flexible Topology and Simple Configuration
- ★ Bus Cycle Time Synchronised with *Motion Coordinator* Servo Period
- ★ Ethercat Protocol to Individual Modules Using the EBUS System
- ★ I/O Functions Tightly Synchronised to Motion Using Ethercat Distributed Clocks
- ★ Practical Push-In Connector Options – No Break Outs Required
- ★ Clip-Together Design With 'Quick Release' Locks For Mechanical Integrity
- ★ RoHS, CE and UL Approved

EtherCAT®

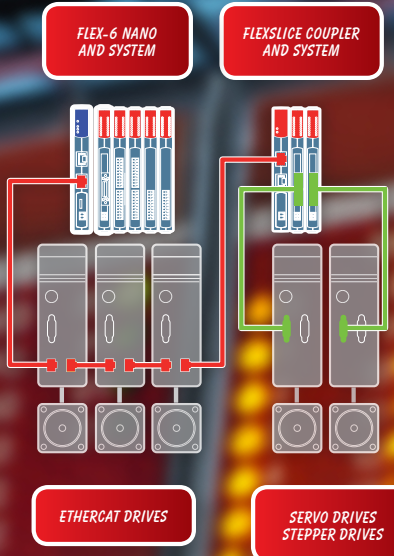

- EXPANSION:**
- P366 Flexslice EtherCAT Coupler
 - P371 Flexslice 16-Out PNP
 - P372 Flexslice 16-In PNP
 - P375 Flexslice Flex 3-Axis
 - P376 Flexslice 16-Out NPN
 - P377 Flexslice 16-In NPN
 - P378 Flexslice 8 Analogue Outputs
 - P379 Flexslice 8 Analogue Inputs
 - P367 Flexslice Thermocouple *
 - P373 Flexslice 8-In 8-Out*
 - P374 Flexslice Analogue 2 Servo Axes*
- * Coming soon

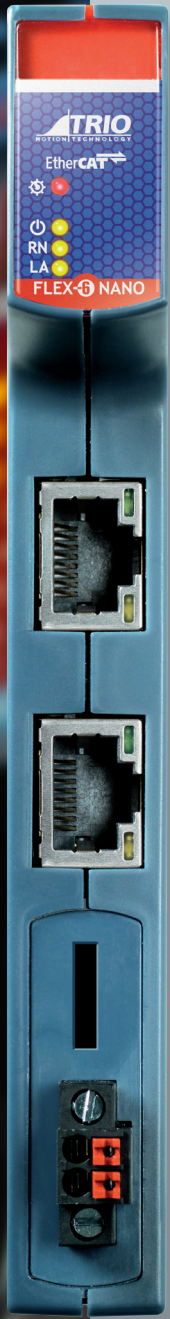

To help with identification, each Flexslice module incorporates a handy removable tab that can be written on. It simply slides in and out of a slot at the top of each module.



The Micro SD Card port allows the memory to be expanded to up to 32 GByte.

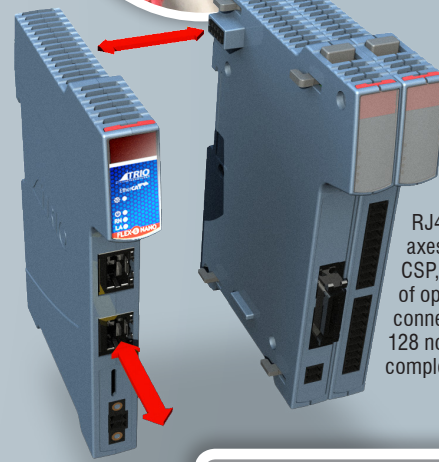

EtherCAT slave nodes are connected via the Flexslice EBUS and the EtherCAT connector (lower RJ45 socket). Up to 64 axes are supported using CSP, CSV and CST modes of operation. Total slave connections can be up to 128 nodes including I/O and complex devices.

- HIGHLIGHTS:**
- Multitasking Operating System
 - Comprehensive Motion Library
 - TrioBasic Motion Language
 - IEC611-3 Programming
 - UNIPLAY HMI Support
 - Robotic Functions
 - Multi-protocol Communications Support



The Flex-6 Nano plugs straight into the Flexslice System via the EBUS connector allowing expansion of the system.

PRODUCT CODES:

P600	Flex-6 Nano	2 Axes
P601	Flex-6 Nano	4 Axes
P602	Flex-6 Nano	8 Axes
P603	Flex-6 Nano	16 Axes
P604	Flex-6 Nano	32 Axes
P605	Flex-6 Nano	64 Axes

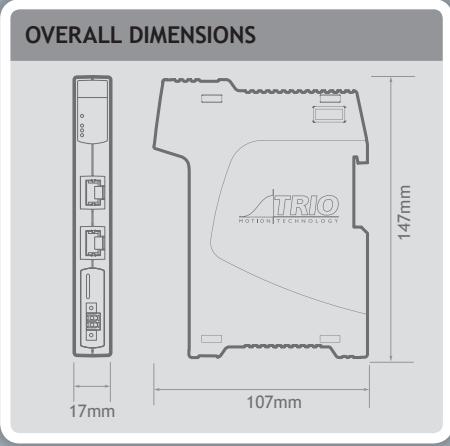

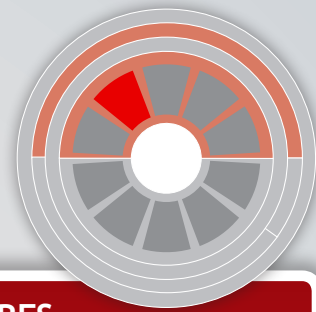

MC6N-ECAT EtherCAT Motion Coordinator

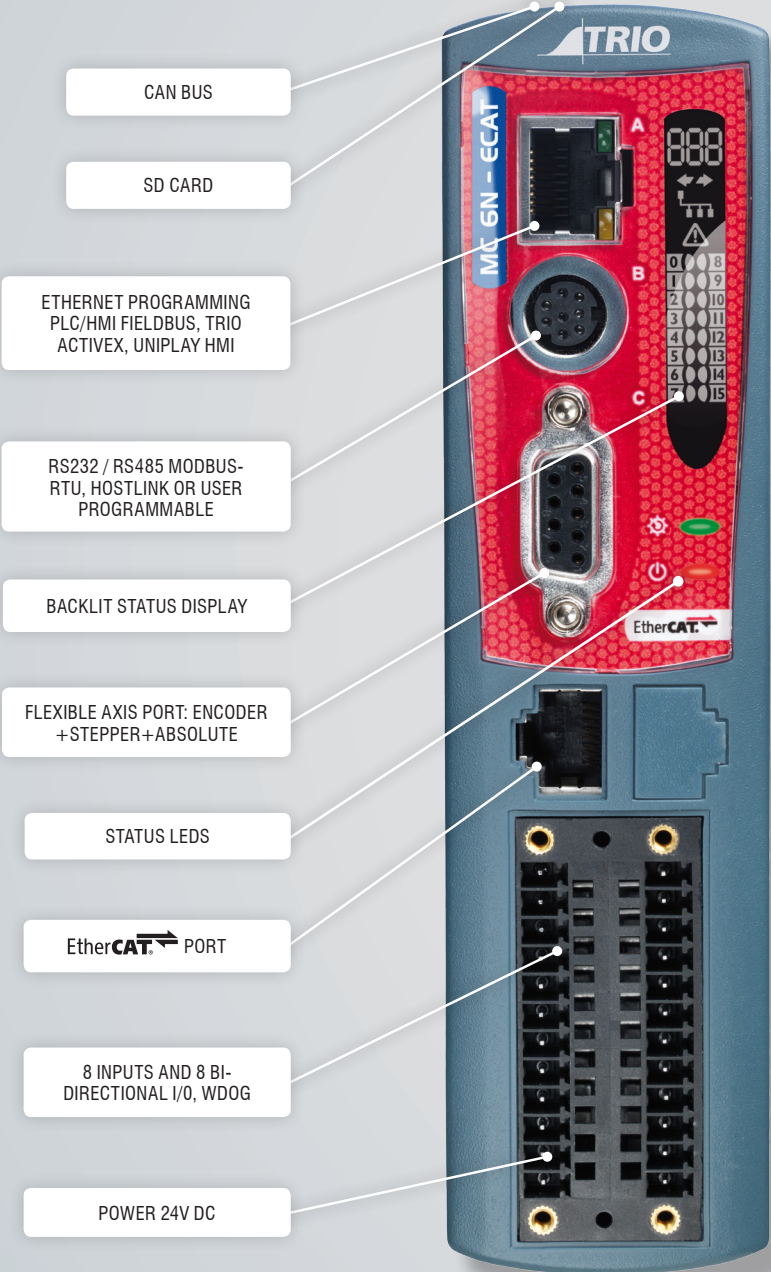

The MC6N is a high performance *Motion Coordinator* which is able to run up to 64 remote servo and stepper drives via the EtherCAT real time bus. It runs a 1GHz Dual Core processor making it ideal for high axis count machines or robotic applications.

The MC6N-ECAT supports up to 64 axes of motion with 64 bit integer position registers for ultra precise axis resolution. EtherCAT slave drives and I/O can be connected and run in cyclic synchronous position, speed or torque modes provided these are supported by the drive. Programming the MC6N is identical to using traditional analogue axes with the addition of being able to set up drives and process alarms over the EtherCAT bus. Trio's Flexslice EtherCAT I/O system is an ideal addition for expanding your system. With everything programmed from one place within *Motion Perfect*, machine control has never been so easy.

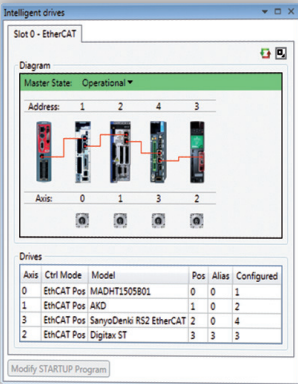

FEATURES

- * Up to 64 EtherCAT Digital Drive Axes
- * EtherCAT Cycle Times Down to 125 μsec
- * 1 GHz i.MX7 Dual ARM Cortex A7 Core Processor
- * 128 Mbyte DDR3 Memory
- * 128 Mbyte Fast Serial NOR Flash
- * Real Time Clock
- * Up to 1024 EtherCAT I/O
- * 8 Digital IN (inc 4x fast reg inputs)
- * 8 Digital Bi-directional I/O
- * Ethernet Port Supports Ethernet IP, Profinet, MODBUS, LAN and WAN
- * RS485 and RS232 Port
- * Supports Position, Speed and Torque Drive Modes
- * Biss, EnDAT and SSI Absolute Encoder Supported
- * Flexible CAM shapes, Linked Motion
- * Hardware Linked Output for Camera / Laser Control
- * Isolated Stepper/Encoder Port
- * SD Memory Card Slot
- * CANopen I/O Expansion
- * Backlit LCD Display
- * RoHS 2 and CE Approved



The built-in Ethernet port allows programming and connection of common PLC and HMI protocols, including the Trio UNIPLAY range of HMIs, directly to the MC6N. User programs can be written in Trio's established multi-tasking TrioBASIC language using the powerful *Motion Perfect v4* application development software making complex motion easy. The industry standard IEC 61131-3 languages are available as an option, allowing a fully functional PLC programming system.

Every axis can be programmed to move using linear, circular, or helical or spherical interpolation, electronic cams, linked axes and gearboxes. The power of the controller allows for multiple robotic transformations to run simultaneously.

A bright easy to read backlit display enables the controller status to be easily determined, whilst the single piece metal cast backplate provides an integrated earth chassis to improve noise rejection in the industrial environment.

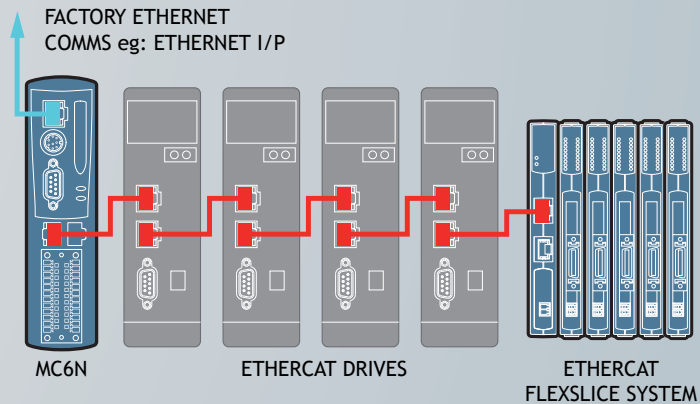

OVERALL DIMENSIONS:

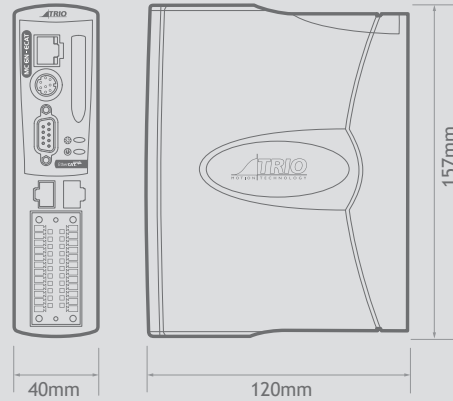

ACCESSORIES:

P366 - P379	EtherCAT Flexslice System
P317 - P327	CAN I/O Modules
P750	Kinematic Runtime FEC
P843 - P844	UNIPLAY 7" & 10" HMI's

PRODUCT CODES:

P960	MC6N-ECAT 2 Axis
P961	MC6N-ECAT 4 Axis
P962	MC6N-ECAT 8 Axis
P963	MC6N-ECAT 16 Axis
P964	MC6N-ECAT 32 Axis
P965	MC6N-ECAT 64 Axis

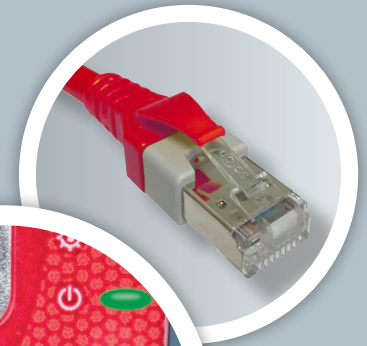

MC664-X MC664

Quad Core 128 Axis Motion Coordinator

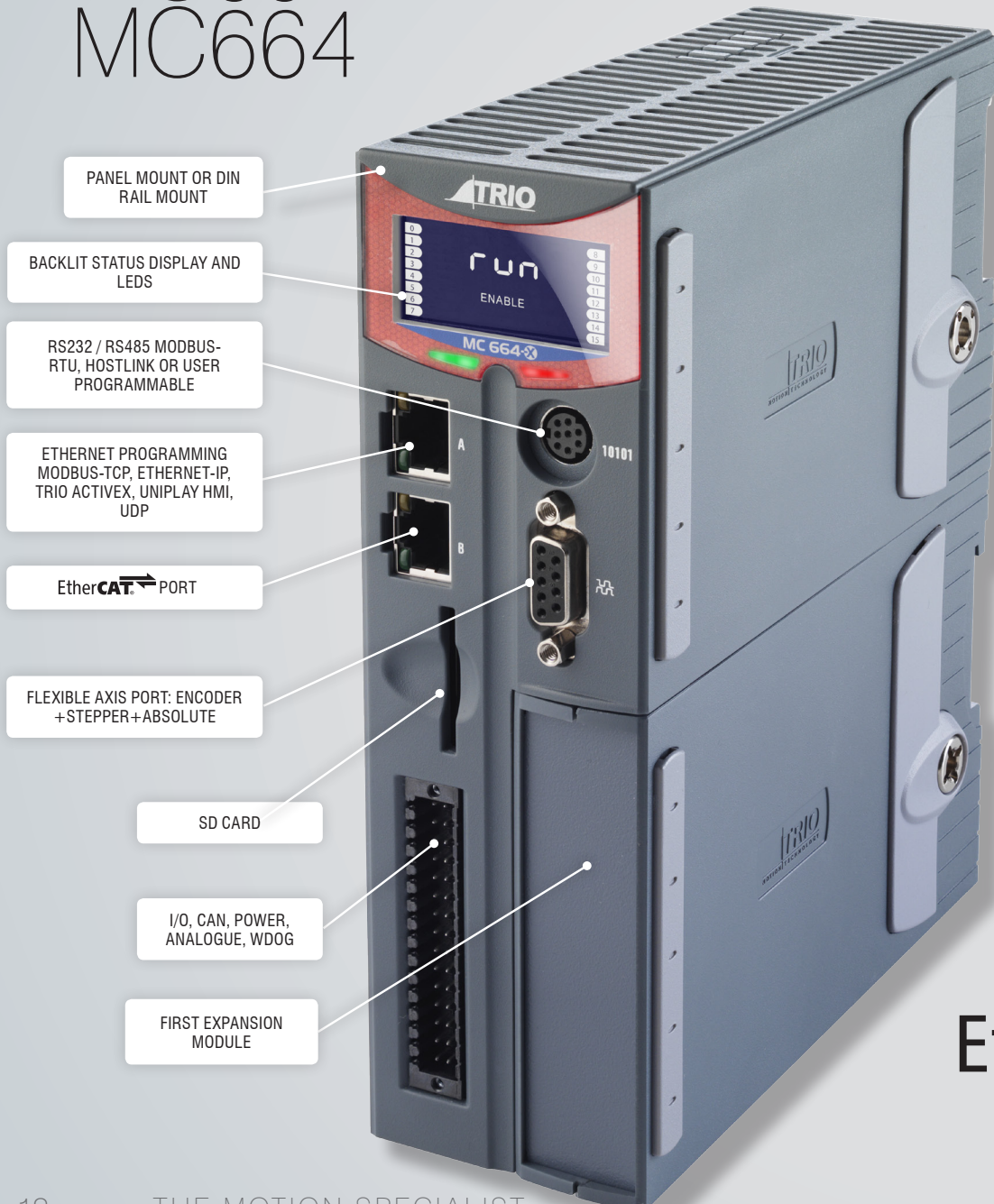
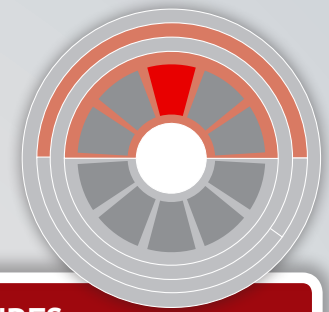

PANEL MOUNT OR DIN RAIL MOUNT

BACKLIT STATUS DISPLAY AND LEDES

RS232 / RS485 MODBUS-RTU, HOSTLINK OR USER PROGRAMMABLE

ETHERNET PROGRAMMING MODBUS-TCP, ETHERNET-IP, TRIO ACTIVEV, UNIPLAY HMI, UDP

EtherCAT PORT

FLEXIBLE AXIS PORT: ENCODER + STEPPER + ABSOLUTE

SD CARD

I/O, CAN, POWER, ANALOGUE, WDOG

FIRST EXPANSION MODULE

The MC664 / MC664-X is Trio's highest performance and most flexible *Motion Coordinator* and is based on the Quad Core Cortex A9 1GHz ARM processor.

The MC664 (single core) and MC664X feature a total of 128 axes in software with up to 64 motor axes and 64 bit integer position registers. 64 bit floating point calculations are used for ultra precise axis resolution. Using expansion modules the MC664 range support up to 64 networked digital drives, 24 analogue servo drives, 25 pulse and direction drives and 25 absolute and incremental encoders.

FEATURES

- * Up to 128 Axes - 64 Stepper / Servo Axes and 64 Virtual Axes
- * Precise 64 Bit Motion Calculations with Quad Core Cortex A9 1GHz Processor (P862)
- * Dedicated Communications Core
- * Built-in EtherCAT Port
- * EtherCAT, Sercos, SLM and RTEK Digital Drive Interfaces
- * Linear, Circular, Helical and Spherical Interpolation
- * Flexible CAM shapes, Linked Motion
- * EnDAT and SSI Absolute Encoder Supported
- * Hardware Linked Outputs for Camera / Laser Control
- * Ethernet-IP / Modbus TCP / Ethernet Interface Built-In
- * Anybus-CC Module for Flexible Factory Comms Including ProfiNet/Profibus
- * IEC 61131-3 Programming Option
- * Multi-tasking BASIC Programming
- * Text File Handling
- * Robotic Transformations
- * SD Memory Card Slot
- * CANopen I/O Expansion
- * Backlit LCD Display
- * RoHS, UL and CE Approved



Every axis can be programmed to move using linear, circular or helical or spherical interpolation, electronic cams, linked axes and gearboxes. The quad core 1GHz processing power allows for multiple robotic transformations to run simultaneously.

The built-in Ethernet port allows programming and connection of common HMI and PLC protocols directly to the MC664. User programs can be written in Trio's established multi-tasking TrioBASIC language using the powerful *Motion Perfect* application development software making complex motion easy. Also available as an option are the industry standard IEC 61131-3 languages allowing a fully functional PLC programming system.

A bright easy to read backlit display enables the controller status to be easily determined, whilst the single piece metal cast backplate provides an integrated earth chassis to improve noise rejection in the industrial environment.

Available in single or quad core formats, the P862 quad core version has 2 built-in EtherCAT axes which can be upgraded with the purchase of the P914 Remote Axes FEC.

The MC664 single core *Motion Coordinator* is a "drop-in" replacement for the MC464 as it uses the same footprint as its predecessor. It has a built-in EtherCAT port but no axes are enabled by default.

OVERALL DIMENSIONS (INC EXPANSION MODULE)

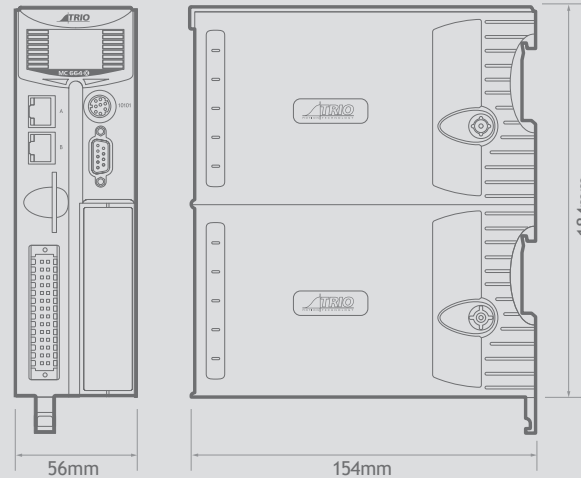

PRODUCT CODES:

P861	MC664	Single Core Processor
P862	MC664X	Quad Core Processor

QUAD CORE MC664X:



ACCESSORIES

P871	MC664 RTEX Interface
P872	MC664 Sercos Interface
P873	MC664 SLM Interface
P876	MC664 EtherCAT Interface
P879	MC664 FlexAxis 4 Interface
P874	MC664 FlexAxis 8 Interface
P381	MC664 FlexAxis Splitter Cable
P875	MC664 Anybus-CC Module
P878	MC664 Blanking Module
P750	Kinematic Runtime FEC
P366 - P379	EtherCAT Flexslice System
P317 - P327	CAN I/O Modules
P843 - P844	UNIPLAY 7" & 10" HMI's
P914	2 x EtherCAT Axes



MC664 / MC664-X Expansion

Configure your application by connecting up to 7 half-height expansion modules or 3 full-height expansion modules.

Each module easily attaches to the controller with a high density bus connection and a uniquely designed screw integrates the earth planes of all modules and *Motion Coordinator* together. Trio's feature enable code system for axis activation allows the whole system to be scaled exactly to your requirements.

The P876, P872 and P871 all come equipped with two axes per module as standard. To add further axes, the P914 Feature Enable Code can be purchased. Each P914 doubles the available axes:

P861 + P914	= 2 Remote Axes	P862 + P914	= 4 Remote Axes
P861 + 2 x P914	= 4 Remote Axes	P862 + 2 x P914	= 8 Remote Axes
P861 + 3 x P914	= 8 Remote Axes	P862 + 3 x P914	= 16 Remote Axes
P861 + 5 x P914	= 16 Remote Axes	P862 + 5 x P914	= 64 Remote Axes

The enabled axes can be used via the built-in EtherCAT port or via the P876, P872 and P871 Expansion Modules.



MC664 EXPANSION OPTIONS

	P876	P872	P871	P873	P878	P875
Network	EtherCAT	Sercos II	Panasonic (RTEX)	SLM	Blanking module to ensure the system is "tied" together mechanically if there are any gaps in the build. There is no communication bus connection, but the P878 is required for the earth connection.	The CompactCom Module adds support for the Anybus CompactCom device modules listed below and bought separately. Profibus, DeviceNet, CANopen, CC-Link, EtherNet IP, USB, Modbus-TCP, Modbus-RTU, RS232, RS485, Profinet I/O, Bluetooth.
Network Speed	100Mbps	4, 8 or 16Mbps	100Mbps	SLM Standard		
Topology	Chain	Ring	Ring	Star		
Max Axes per Interface	64	16	32	6		
Max Interfaces per MC664	7	7	7	7		
Max Axes on MC664	64	64	64	42		
Cable	STP Cat 5-e or better	Fibre Optic	STP Cat 5-e or better	RS485		
Bus to MC664	32 Bit	32 Bit	32 Bit	32 Bit		
Interpolated time based registration	8 x 24V Inputs	8 x 24V Inputs	8 x 24V Inputs	6 x 24V Inputs		
Optically isolated registration inputs	Y	Y	Y	Y		
Map any I/O to any Axis	Y	Y	Y	Y		
Remote Registration	Y	Y	N/A	N/A		



MC664 EXPANSION OPTIONS

For use with Stepper, Analogue Servo and Piezo Motors with support available for SSI/Endat/Tamagawa Absolute encoders. Standard FlexAxis interface modules are available in 4 axis (P879) and 8 axis (P874) versions. An 8 axis SSI absolute encoder version (P881) is available as a special order.



	P874	P879	P881
Axis 0	Core + AS	Core + AS	Core + SSI + AS
Axis 1	Core + AS	Core + AS	Core + SSI + AS
Axis 2	Core + AS	Extended + AS	Core + SSI + AS
Axis 3	Core + AS	Extended + AS	Core + SSI + AS
Axis 4	Extended + AS		Core + SSI + AS
Axis 5	Extended + AS		Core + SSI + AS
Axis 6	Extended + AS		Core + SSI + AS
Axis 7	Extended + AS		Core + SSI + AS
Max Interfaces per MC664	3	3	3
Max Axes on MC664	24	12	24
Connectors: Encoder	15pin HD D-type	15pin HD D-type	15pin HD D-type
Discrete Wiring	Removable terminal block	Removable terminal block	Removable terminal block
Bus to MC664	32 Bit	32 Bit	32 Bit
Registration Inputs*	Flexible registration on all axes	Flexible registration on all axes	Flexible registration on all axes
Position based registration	4 x 24V inputs	4 x 24V inputs	N/A
Bi-direction registration input/position switch output	4 x 24V	4 x 24V	4 x 24V
Optically isolated registration inputs	Yes	Yes	Yes
Map any registration input to any Axis	Yes	Yes	Yes
Independant axis Configuration	Yes	Yes	Yes
No of 16 bit DAC Outputs	8	4	8

* N/A to absolute axes.

CORE AXES – can be configured in software as pulse and direction outputs to stepper or servo drives. They can also be configured for incremental encoder feedback or simulated encoder output.

EXTENDED AXES – in addition to the Core functionality these axes can also be configured for SSI, Tamagawa or EnDat absolute encoders.

AS - Analogue 'closed loop' Servo using built-in $\pm 10V$ analogue output.

P381 - Breakout cable to split the high density D-Type connectors to standard 9 way D type connectors.



PC-MCAT 64

64 Axis EtherCAT Motion Coordinator + PC

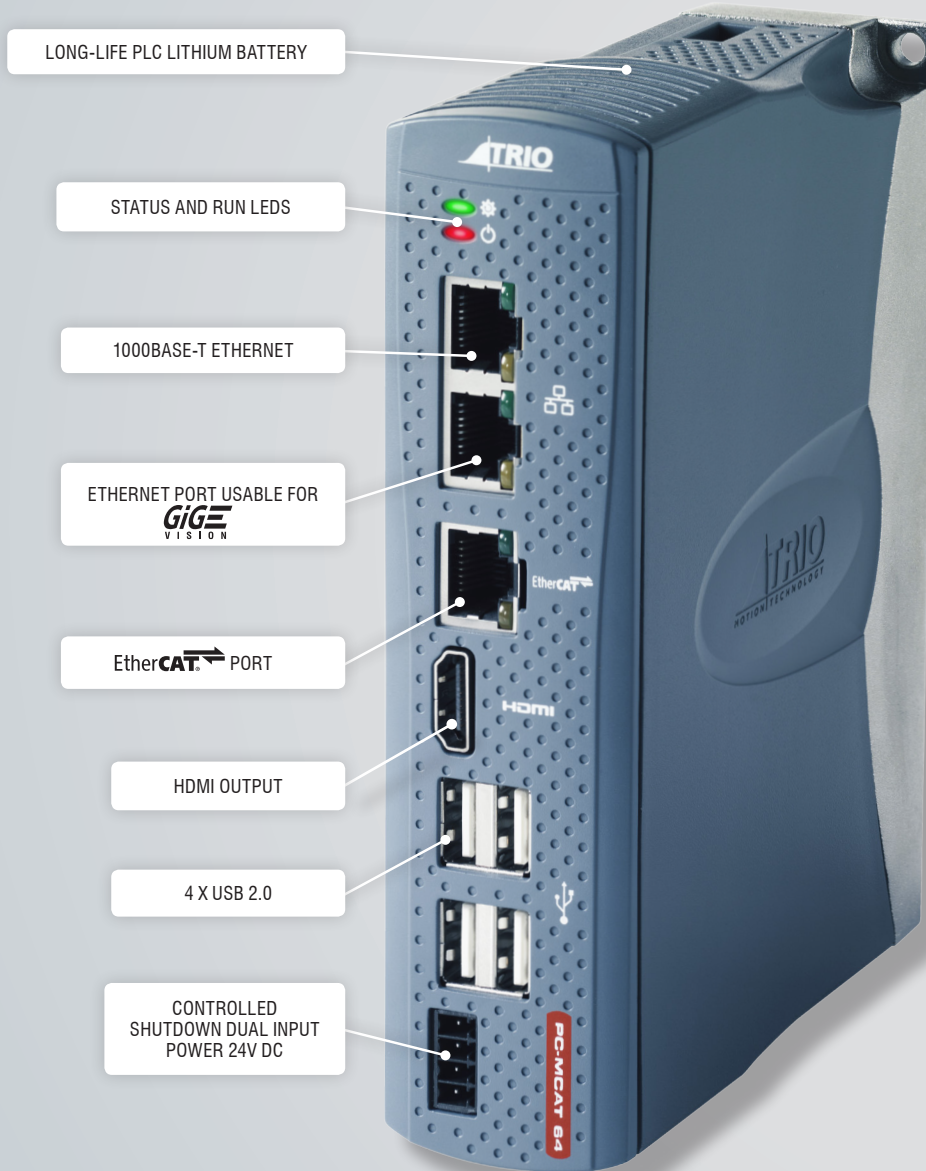

Trio's PC-MCAT 64 is an innovative "Motion + PC Solution". A powerful quad core Intel Atom processor is used to drive both a high performance motion controller and a compact PC that can run user applications under Windows.

The PC-MCAT software uses a real-time extension to allow both Windows and the motion controller to run directly on their own processor cores.

The motion controller's own dedicated EtherCAT master Ethernet port can launch data packets with less than 1µsec of jitter. The 1.91GHz Atom processor is paired with 4 GBytes of RAM and a high speed 64 GByte upgradable SSD to give sufficient PC performance for many machine types.

PC-MCAT is especially suitable where a machine type needs the software and hardware facilities of a PC paired with a powerful 64 axis motion coordinator. The HDMI port can be used to drive high resolution displays for sophisticated operator interfaces.

The large 64 GByte SSD drive can hold vast amounts of machine data and recipes. Two GBit Ethernet ports are built into the PC-MCAT. These can be used for factory communications or connecting vision camera(s) whose data can be processed directly on the PC cores.

A machine's PC applications can communicate with the Trio Motion Coordinator running on its dedicated processor core using fast shared memory. Machine control sequences can either be made in multi-tasking TrioBASIC / IEC61131 of the Motion Coordinator or can be written as a PC application (for example in "C") sending motion + I/O requests through to the Motion Coordinator. Trio's Motion Perfect v4 application development tool can be run directly on the PC-MCAT or remotely on a laptop via Ethernet.

FEATURES

- ★ Motion + PC Solution for Automation Machinery
- ★ Fanless compact PC with E3845 Quad Core Atom Processor at 1.91 Ghz
- ★ Powerful up to 64 Axis EtherCAT Based Trio Motion Coordinator
- ★ RTX64 Real Time Extension to allow Motion + Windows Running Directly on Their Own Processor Cores
- ★ Plug and Play EtherCAT Configuration Expandable Support for Servo Drives, I/O and Devices From Over 100 Manufacturers
- ★ Programmable In Easy TrioBASIC, built-in IEC 61131 or PC based Programming Languages Such As 'C'
- ★ 4 GByte RAM + 64 GByte Upgradable SSD
- ★ Built-in GBit Ethernet Port For Vision Cameras
- ★ RoHS and CE Approved

ACCESSORIES:

P366 - P379	EtherCAT Flexslice System
P750	Kinematic Runtime FEC
P843 - P844	UNIPLAY 7" & 10" HMI's
P912	2 x EtherCAT Axes

PRODUCT CODE:

P760 PC-MCAT 64 EtherCAT Controller

EtherCAT®

SPECIFICATION:

Motion Specification:

Motion Axes	2 / 4 / 8 / 16 / 32 / 64
Servo Cycle	250 / 500 / 1000 / 2000µsec
Drive Modes	Position / Speed / Torque
Interpolation	Linear / Circular / Helical / Spherical / Transition Curves / Tangential
Linked Modes	Cam, Cambox, Flexlink, Movelink, Camlink

EtherCAT Specification:

Speed	100Mbps
Physical Layer	100BASE-TX full duplex (IEEE 802.3)
Cable	Shielded Twisted Pair (TIA/EIA-568B CAT5e)
Topology	Line, tree or star
Isolation	Pulse transformer with common-mode choke
Connector	RJ45
Cable Length	100m max between nodes
Cyclic period	250µsec, 500µsec, 1000µsec or 2000µsec
Synchronisation	Distributed Clocks technology. Jitter <1 µsec
Protocol	CoE, SoE
Number of Axes	64
Number of Nodes	128 slave nodes maximum
Motion modes	Cyclic Synchronous Position, Cyclic Synchronous Velocity, Cyclic Synchronous Torque
Parameter transfer	CoE Object read/write. SoE IDN read/write
Input/Output	Up to 8192

PC Specification:

Processor	Intel Atom™ E3845 Quad Core 1.91 Ghz
Memory	4 Gbytes DDR3
Ethernet	2 x GBit Ethernet + EtherCAT port
HDMI	2560 x 1600 @ 60Hz Max
Audio	Via HDMI
USB	5 USB ports
Battery	8 Year life PLC compatible type. Replaceable without opening case.
Power Supply	24V +/- 20% Isolated Power Supply
Operating Temp	0 deg – 40 deg C
Cooling	Fanless
Operating System	Windows with RTX64 Real Time Extension

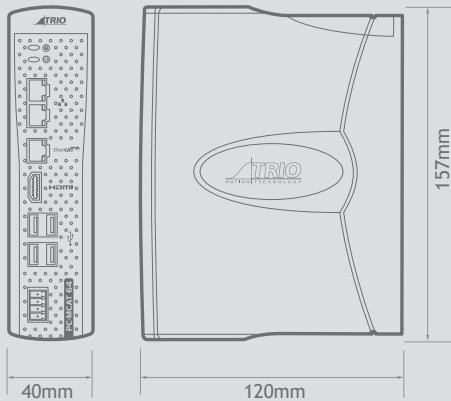

Soft Motion Coordinator

PC-MCAT S

SPECIFICATION:

Minimum System Requirements:

Realtek Ethernet Network card - 8169 architecture:
 One port will be used as the EtherCAT connection
 Intel HyperThreading technology disabled:
 The BIOS must allow this feature to be disabled;
 Any relatively modern intel processor allows this
 Minimum 1 USB port
 Windows 7 / Windows 7 Embedded 64 bits
 RTX64 3.3 Update 2 Runtime or above
 PC-MCAT firmware installation

Minimum Hardware Recommendation:

Intel Atom processor Quad Core 1910 MHz
 4 Gbytes RAM
 4 Gbytes RAM
 2 Ethernet ports (EtherCAT and additional communications)

PRODUCT CODE:

P762 PC-MCAT S (2 Axes) Soft MC

ACCESSORIES:

P750 Robot Kinematic Software FEC
 P912 Axis x 2 upgrade

Run the PC-MCAT Motion Coordinator on a Windows based Industrial PC of your own choice. PC-MCAT S provides all the features of the PC-MCAT in a software package that can be installed on a suitable PC.

This approach allows the user to decide on processor speed, graphics capability and memory size giving a scalable solution that suits your application.

PC-MCAT S may be installed for trials without needing a licence. It will run for one hour after each reset. Full function operation is controlled by a USB dongle supplied by Trio.



Flexslice System

Flexible EtherCAT Devices

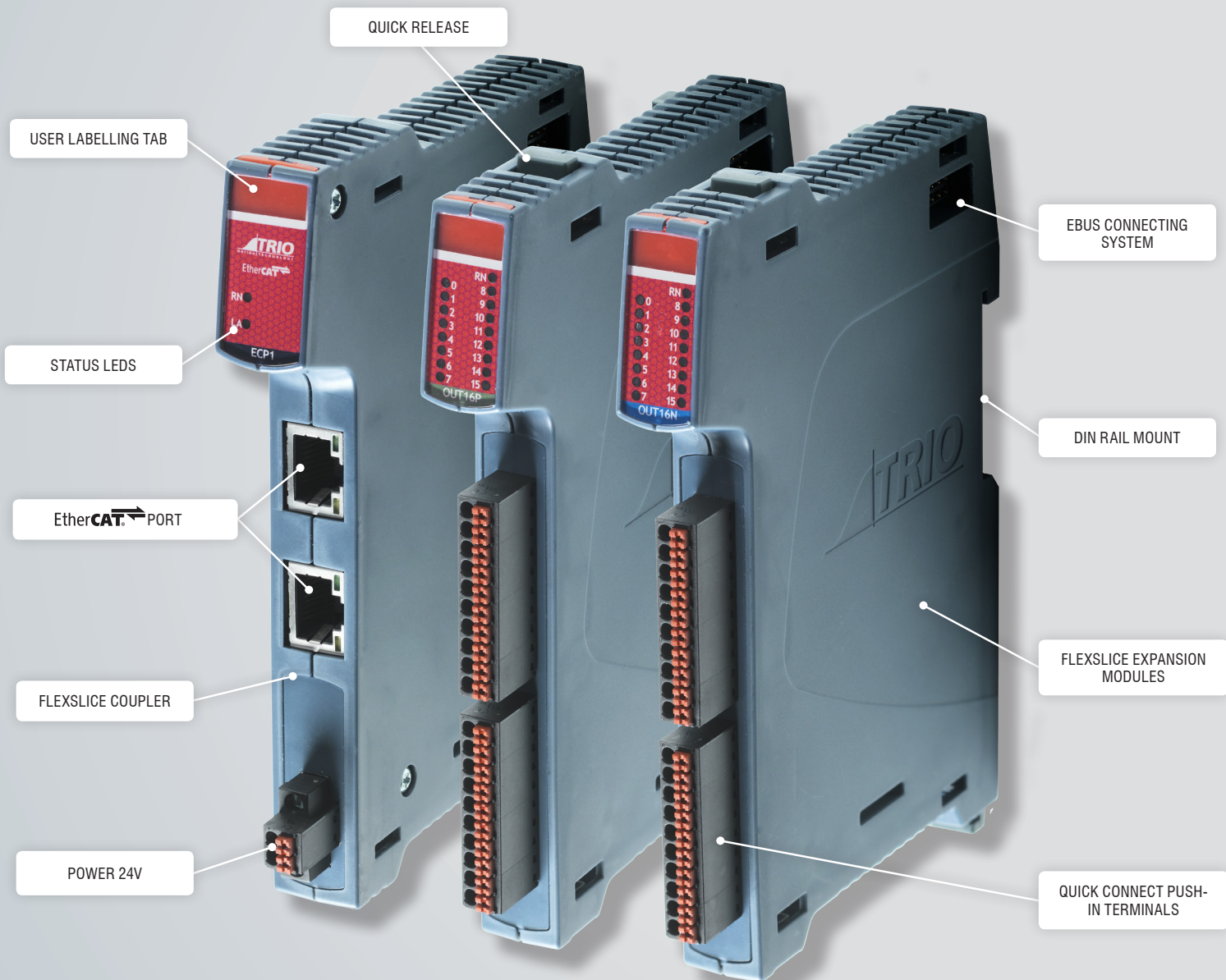
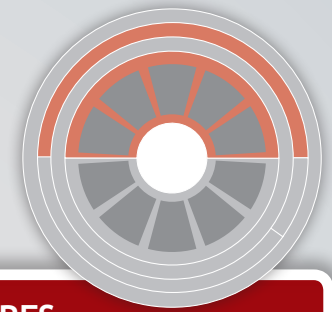

FEATURES

- ★ Use with Trio or 3rd Party EtherCAT Masters
- ★ High Performance, Flexible Topology and Simple Configuration
- ★ Bus Cycle Time Synchronised with *Motion Coordinator* Servo Period
- ★ Bus Coupler Module with 2x RJ45 Ethernet Ports For Ethercat Connection
- ★ Ethercat Protocol Remains Fully Intact Down to Individual Modules Using the E-Bus System
- ★ I/O Functions Tightly Synchronised to Motion Using Ethercat Distributed Clocks
- ★ Automatic Mapping to the *Motion Coordinator* I/O System
- ★ DIN Rail Mounted
- ★ Multiple Practical Push-In Connector Options – No Break Outs Required
- ★ Clip-Together Design With 'Quick Release' Locks For Mechanical Integrity
- ★ User Labelling Facility
- ★ Machine Builder Custom Functionality Options



The EtherCAT Flexslice System is designed to let you do more! It offers fast flexible expansion for motion applications and can be used with Trio or 3rd Party Masters.

Trio's Flexslice input/output modules provide a robust, high speed and flexible solution for both motion control and general automation. EtherCAT cycle times down to 250µsecs are supported and the bus coupler uses EBUS technology to bring all the sub-modules on to the EtherCAT network with no degradation in performance.

The Flexslice system makes available a selection of digital and analogue I/O terminals as well as motion modules with pulse + direction outputs designed for precise positioning of stepper and servo motors via suitable drive technology.

The digital I/O modules have high-speed functionality. In addition, analogue modules and axis modules may be fitted to make a superbly tailored system that can be placed remotely from the master if needed.

All Flexslice modules support automatic addressing with the master to automatically detect and configure the modules on startup. The bus coupler can support up to 16 input/output modules which have a positive mechanical lock and bus connector, making a reliable EBUS connection through the backplane. The complete assembly can be DIN rail mounted.

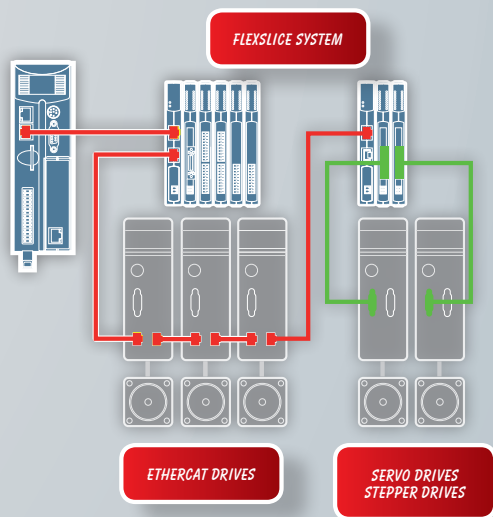

The Flexslice system begins with the coupler.

The coupler is connected to the network via the upper Ethernet interface. The lower RJ45 socket may be used to connect further EtherCAT devices in the same strand.

In the EtherCAT network, the P366 coupler can be installed in any position in the Ethernet string; making it suitable for operation close to the master or at a remote position.

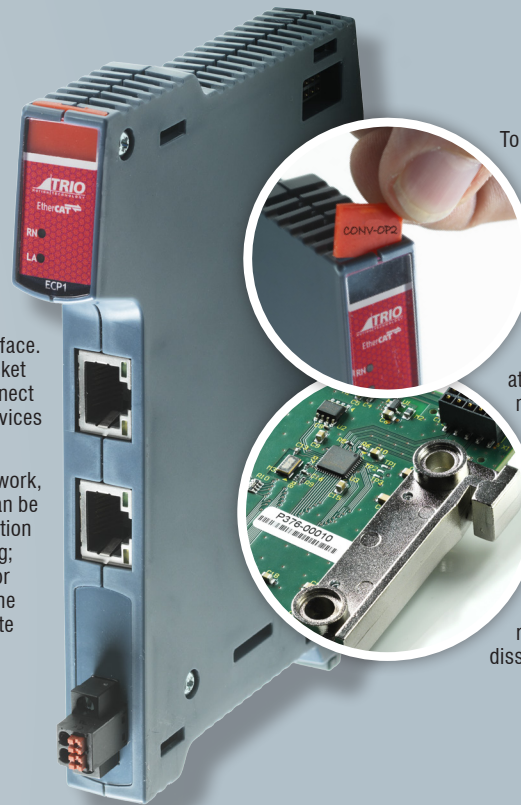

To help with identification, each Flexslice module incorporates a handy removable tab that can be written on. It simply slides in and out of a slot at the top of each module.

The robust metal chassis provides a good earth from the pcb of each module to the DIN rail to reduce noise and dissipate heat.

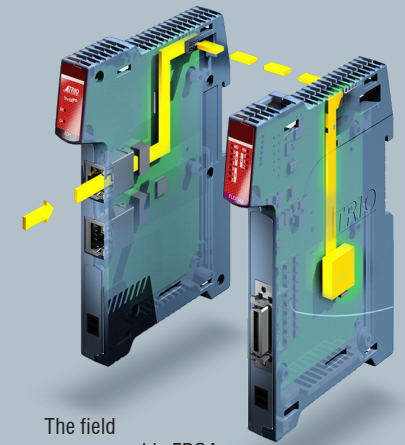

The field programmable FPGA allows customisation of the functionality of some Flexslice Modules using *Motion Perfect v4*. The program can be "locked-down" creating a unique function for a machine builder which protects the functionality from being copied.

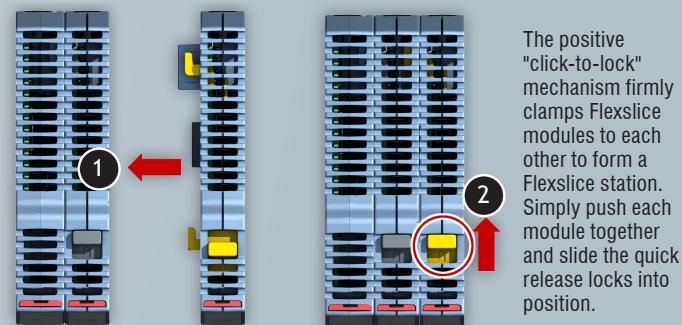

The positive "click-to-lock" mechanism firmly clamps Flexslice modules to each other to form a Flexslice station. Simply push each module together and slide the quick release locks into position.

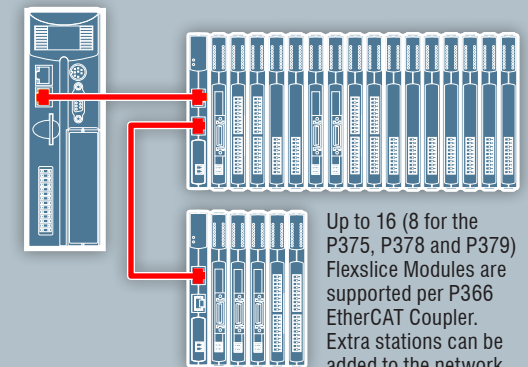

Up to 16 (8 for the P375, P378 and P379) Flexslice Modules are supported per P366 EtherCAT Coupler. Extra stations can be added to the network using the second EtherCAT port.

Flexslice System Flexible EtherCAT Devices

P366: ETHERCAT COUPLER

The P366 Flexslice EtherCAT Coupler connects EtherCAT with the EtherCAT slices. One station consists of a P366 Coupler and up to 16 Flexslice EtherCAT modules. The Coupler converts the passing telegrams from Ethernet 100BASE-T to EBUS signal format.

Power supply requirement	24V DC, 0.8A min for full system
EtherCAT Connection	RJ45
Protocol	EtherCAT
Data rate	100 Mbit/s
Dimensions (mm)	17.2w x 147h x 107d
Weight	160g
Network Cable	CAT5e min
Compliance	RoHS, CE and UL

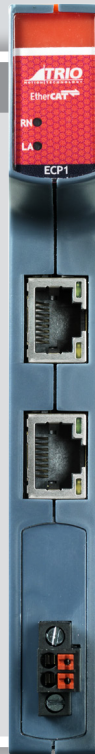

PRODUCT CODES:

P366	Flexslice EtherCAT Coupler
P371	Flexslice 16-Out PNP
P372	Flexslice 16-In PNP
P375	Flexslice Flex 3-Axis
P376	Flexslice 16-Out NPN
P377	Flexslice 16-In NPN
P378	Flexslice 8 Analogue Outputs
P379	Flexslice 8 Analogue Inputs
P367	Flexslice Thermocouple *
P373	Flexslice 8-In 8-Out*
P374	Flexslice Analogue 2 Servo Axes*

* Coming soon

P371: 16-OUT PNP

The P371 digital output Flexslice connects the binary control signals from the *Motion Coordinator* to the machine's output devices at 24V DC. All 16 outputs are current sourcing (PNP) type and have electrical isolation. Outputs and power connection are via 2 x single-row push-in connectors. The Flexslice module indicates the output signal states via LEDs.

Module current consumption (EBUS 5V)	110mA max
Number of Digital Outputs	16 (2 banks of 8)
Power supply requirement	24V (+/-20%) DC
Load type	Resistive, inductive and capacitive
"ON" time	110us (10% to 90%)
"OFF" time	210us (90% to 10%)
Max. Output current	0.5A per channel
Max. Output current	4A per bank of 8 Outputs
Short-Circuit Protection	1.4A typ per output
Over voltage Protection	Yes
Reverse Voltage Protection	Yes



P372: 16-IN PNP

The P372 digital input Flexslice connects 24V DC signals from devices on the machine to the binary control registers in the *Motion Coordinator*. All 16 inputs are current sinking (PNP) type and have electrical isolation. Inputs and power connection are via 2 x single-row push-in connectors. The Flexslice module indicates the input signal states via LEDs.

Module current consumption (EBUS 5V)	100mA max
Number of Digital Inputs	16 (2 banks of 8)
Power supply requirement	24V (+/-20%) DC
"ON" Voltage threshold	11.2V typ
"OFF" Voltage threshold	10.2V typ
Input current	3.5mA typ
Input filter Cut-off (RC network)	18KHz



P375: FLEX 3-AXIS

The P375 Flex 3 Axis Module allows up to 3 stepper motors or encoders to be connected to a control system. It supports incremental encoders. If configured for stepper / pulse output an axis can be pulse+direction or quadrature simulated encoder output. A single MDR connector provides a reliable shielded 26 way connector for high speed signals. The P375 is compatible with most high-resolution microstep drives.

Max Step Rate	8MHz pulse count
Step / Pulse Width	Pulse Control or Square Wave
Max Enc Rate	8MHz encoder count
Module current consumption (EBUS 5V)	150mA max
Field Programmable	Yes
Step/Enc Port	MDR Connector 0...5V
Max Axes	3 (software configurable)
WDOG Output	Yes



EtherCAT®

P376: 16-OUT NPN

The P376 digital output Flexslice connects the binary control signals from the *Motion Coordinator* to the machine's output devices, such as relays, contactors, valves, lamps etc. at 24V dc. All 16 outputs are current sinking (NPN) type and have electrical isolation. Outputs and power connection are via 2 x single-row push-in connectors. The Flexslice module indicates the output signal states via LEDs.

Module current consumption (EBUS 5V)	110mA max
Number of Digital Outputs	16 (2 banks of 8)
Power supply requirement	24V (+/-20%) DC
Load type	Resistive, inductive and capacitive
"ON" time	75us (90% to 10%)
"OFF" time (typ)	105us (10% to 90%)
Max. Output current	0.5A per channel
Max. Output current	4A per bank of 8 Outputs
Short-Circuit Protection	3A typ per output
Over voltage Protection	Yes
Reverse Voltage Protection	Yes



P377: 16-IN NPN

The P377 digital input Flexslice connects 24V dc signals from devices on the machine to the binary control registers in the *Motion Coordinator*. All 16 inputs are current sourcing (NPN) type and have electrical isolation. Inputs and power connection are via 2 x single-row push-in connectors. The Flexslice module indicates the input signal states via LEDs.

Module current consumption (EBUS 5V)	100mA max
Number of Digital Inputs	16 (2 banks of 8)
Power supply requirement	24V (+/-20%) DC
"ON" Voltage threshold	13.7V typ
"OFF" Voltage threshold	14.6V typ
Input current	3.5mA
Input filter Cut-off (RC network)	18KHz



P378: 8 ANALOGUE OUTPUTS

The P378 Flexslice 8 Analogue Output module has eight programmable voltage range output terminals, each digitised to a resolution of 12 bit. The 8 single ended outputs have a common 0V potential and are brought out to a single push-in connector.

Power Supply	via the EBUS
Module current consumption (EBUS 5V)	200mA max
Signal voltage	-10...+10V; 0...+10V
Signal current	+/-6mA max
Resolution	12 bit
Output impedance	0.5ohm
Number of Analogue Outputs	8



P379: 8 ANALOGUE INPUTS

The P379 Flexslice 8 Analogue Input module has eight programmable voltage range input terminals, each digitised to a resolution of 12 bit. The 8 single ended inputs have a common 0V potential and are brought out to a single row push-in connector.

Power Supply	via the EBUS
Module current consumption (EBUS 5V)	160mA max
Signal voltage	-5V... +5V; 0V... +5V; -10V...+10V; 0V...+10V
Signal current	0...20mA
Resolution	12 bit
Overvoltage protection	±25V
Number of Inputs	8



ALL FLEXSLICE MODULES

Connectors	Push-in
Cable length (max)	30m
Dimensions (mm)	15w x 147h x 107d
Weight	145 g
EtherCAT refresh cycle	≥ 125us
Isolation	1KV
Compliance	RoHS and CE

OVERALL DIMENSIONS

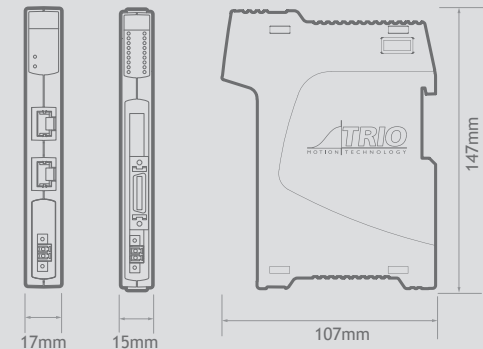

UNIPLAY HMI

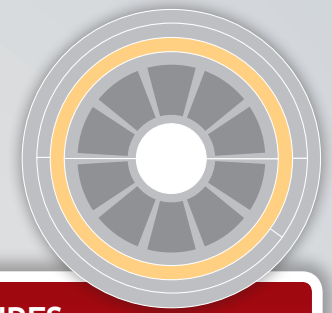

STATUS LEDS

BRIGHT, HIGH-CONTRAST
65536 COLOUR TFT DISPLAY

7" AND 10" VERSIONS



ETHERNET, COM, USB SD
CARD PORTS

PANEL AND VESA MOUNTABLE

FEATURES

- * Single Point HMI Programming Inside *Motion Perfect v4*
- * Centralised Program / HMI screen Storage in a *Motion Perfect* Project
- * Easily Display any Controller Data Type and Graphics
- * No Need to Separately Program HMI Panel
- * 7" and 10" UNIPLAY Sealed Touch Panels Available
- * Ethernet Connection Reduces Wiring

Trio's unique UNIPLAY HMI system is a revolutionary way to make operator interfaces better, easier and more secure! The UNIPLAY series boasts a 7" and 10" colour display.

The UNIPLAY range has built-in power isolation technology making it more reliable in noisy environments.

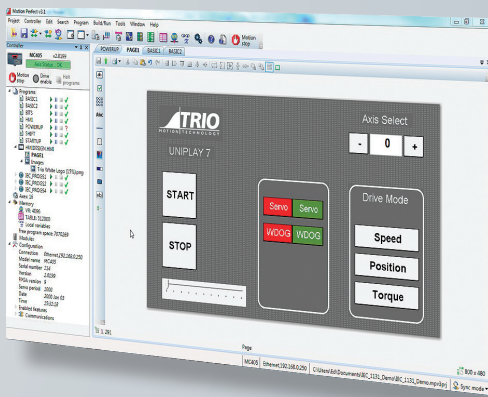
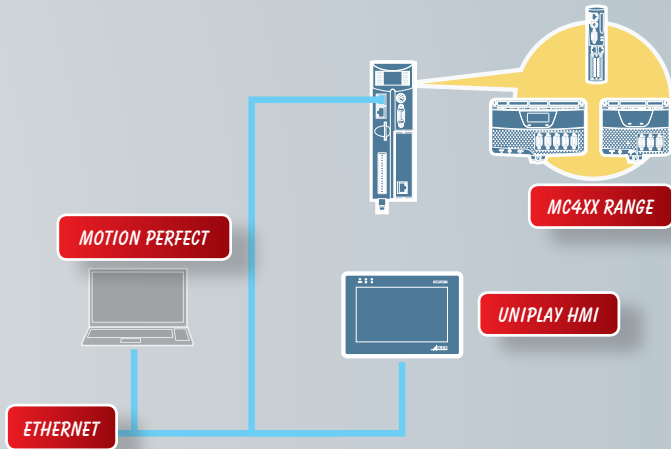

No additional software is required; UNIPLAY HMI's work with the Trio MC4+ *Motion Coordinator* range. *Motion Perfect v4* is used to create operator HMI screens which are transferred to the UNIPLAY HMI by the *Motion Coordinator* at runtime.

OVERALL DIMENSIONS P843 AND P844

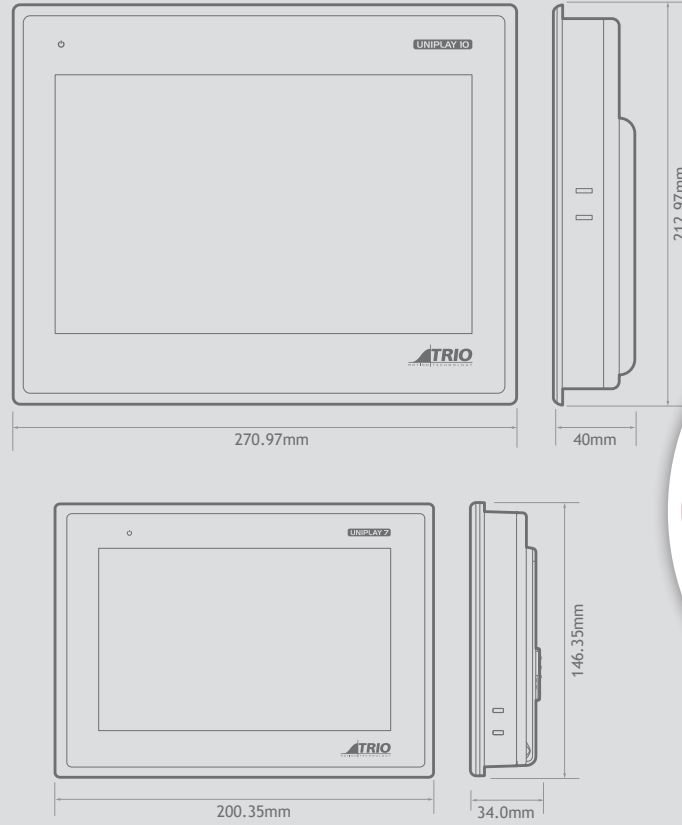

UNIPLAY PRODUCT OPTIONS

P843	P844
UNIPLAY 7"	UNIPLAY 10"

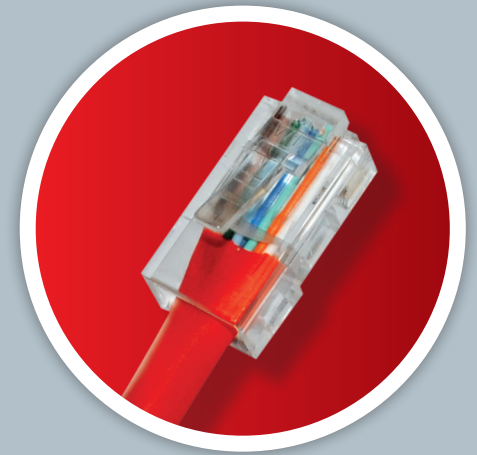

MC403 MC403-Z

2 Servo / 3 Stepper Axis *Motion Coordinator*

2 / 3 Stepper Axis *Motion Coordinator*

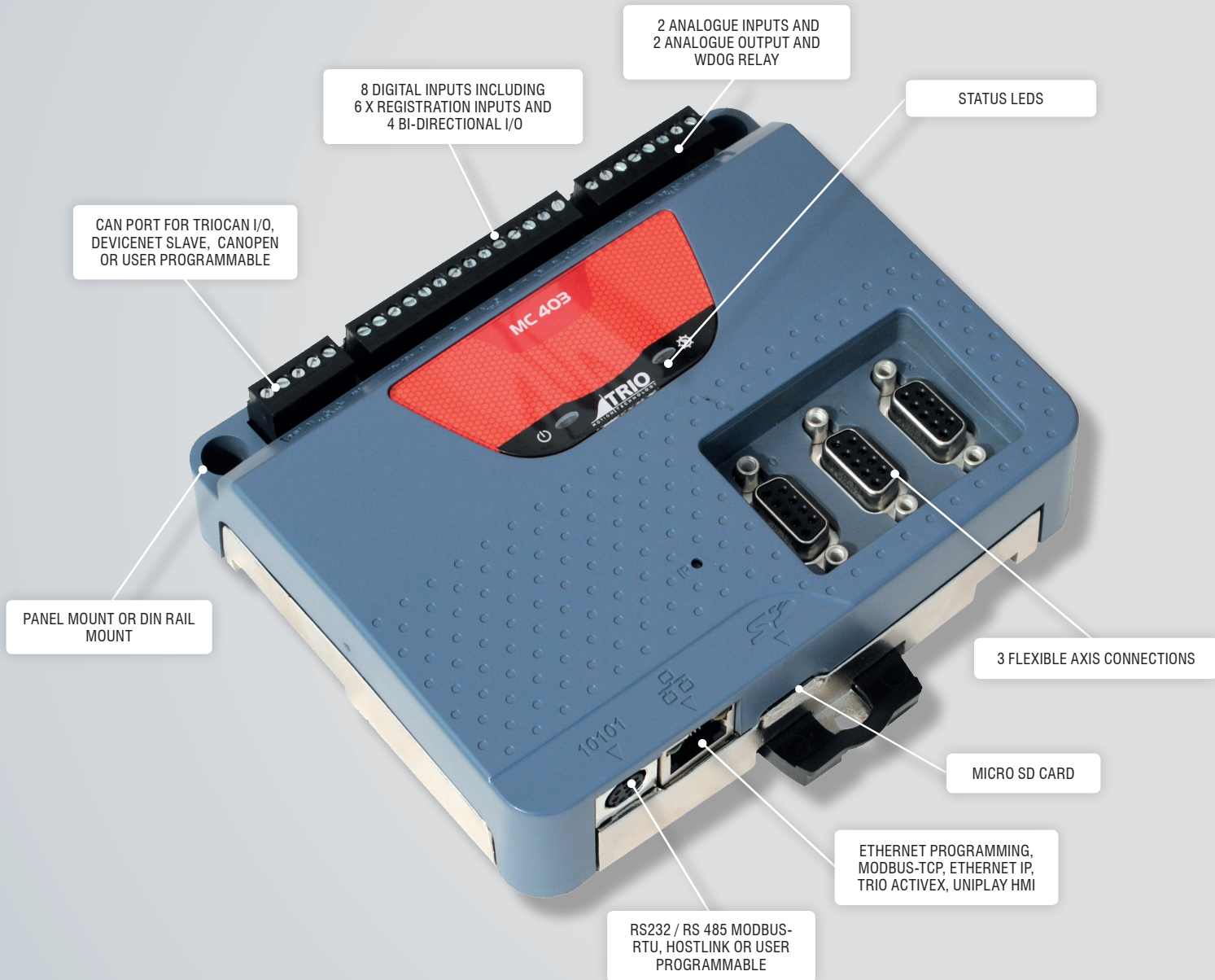
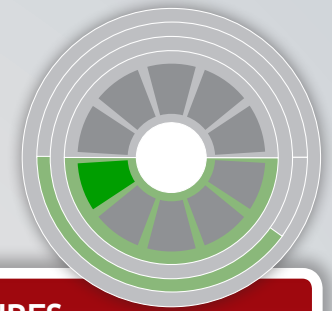

FEATURES

- ★ Advanced 2 Axis Closed Loop Servo / 3 Axis Pulse Direction
- ★ Linear, Circular, Helical and Spherical Interpolation
- ★ Flexible CAM shapes, Linked Motion
- ★ EnDAT and SSI Absolute Encoder Supported
- ★ Hardware Linked Outputs for Camera / Laser Control
- ★ Ethernet-IP / Modbus TCP / Ethernet Interface Built-In
- ★ 125 – 2000µsec Selectable Servo Update
- ★ Precise 64 bit Motion Calculations on ARM11 Processor with VFP
- ★ IEC 61131-3 Programming
- ★ Multi-tasking BASIC Programming
- ★ Text File Handling
- ★ Robotic Transformations
- ★ Micro SD Memory Card Slot
- ★ CANopen I/O Expansion
- ★ RoHS, UL and CE Approved

The MC403 is a high specification *Motion Coordinator* using a high performance ARM11 processor, with three flexible axis ports and two Voltage outputs over a range of 5 model variants.

The flexible axis ports can be configured in software as feedback devices or pulse direction outputs. As outputs they can be used as pulse and direction with stepper or servo drives or they can operate as a simulated encoder output. When configured as feedback they can be either incremental encoder input or one of three popular absolute encoder types; SSI, Tamagawa or Endat. Any feedback axis with a Voltage output can be used to form a closed loop servo.

The built-in Ethernet port allows programming and connection of common HMI and PLC protocols directly to the MC403. User programs can be written in Trio's established multi-tasking TrioBASIC language using the powerful *Motion Perfect v4* application development software making complex motion easy. Also available as an option are the industry standard IEC 61131-3 languages allowing a fully functional PLC programming system.

The MC403 is available in 2 model formats offering 5 different axis configurations. The entry level MC403-Z does not have a built-in DAC. All models feature a total of 16 axes in software. Any axes not assigned to built-in hardware can be used as a virtual axis. Every axis can be programmed to move using linear, circular, helical or spherical interpolation, electronic cams, linked axes and gearboxes.

Two LED's enable the controller status to be easily determined, whilst the single piece metal cast backplate provides an integrated earth chassis to improve noise rejection in the industrial environment.

ACCESSORIES:

- P317 - P327 CAN I/O Modules
- P750 Kinematic Runtime FEC
- P843 - P844 UNIPLAY 7" & 10" HMI's

OVERALL DIMENSIONS:

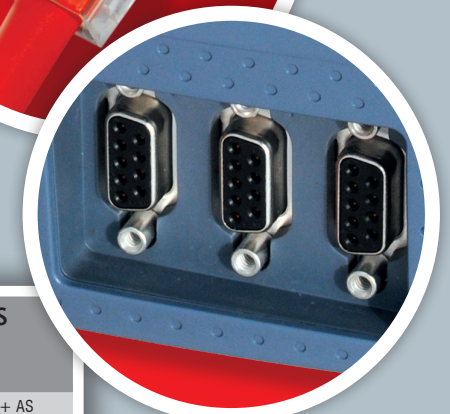
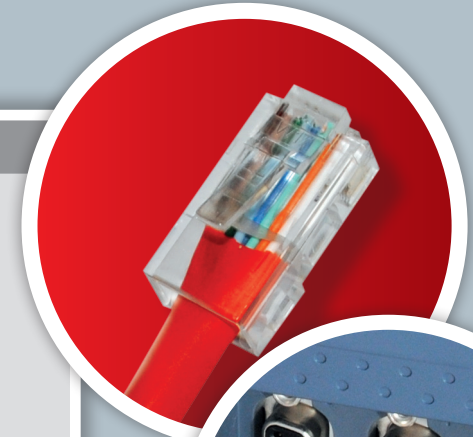
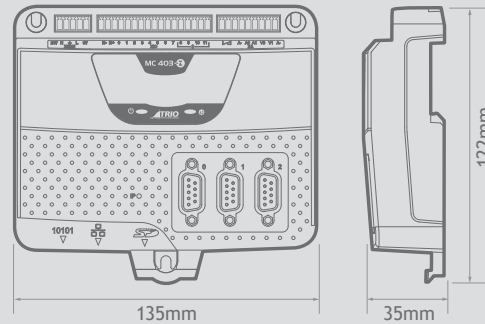

MC403-Z PRODUCT OPTIONS			MC403 PRODUCT OPTIONS		
	P821	P822	P825	P823	P824
Axis 0	Core	Core	Extended + AS	Core	Extended + AS
Axis 1	Core	Core		Core	Extended + AS
Axis 2		Extended	Core	Core	Extended

CORE AXES – can be configured in software as pulse and direction outputs to stepper or servo drives. They can also be configured for incremental encoder feedback or simulated encoder output.

EXTENDED AXES – in addition to the Core functionality these axes can also be configured for SSI, Tamagawa or EnDat absolute encoders.

AS - Analogue 'closed loop' Servo using built-in $\pm 10V$ output.



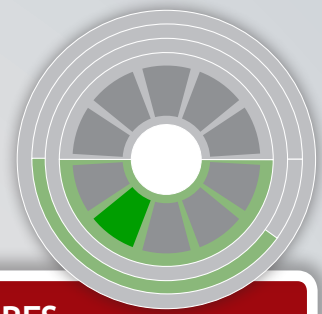

MC405 4 / 5 Axis Motion Coordinator

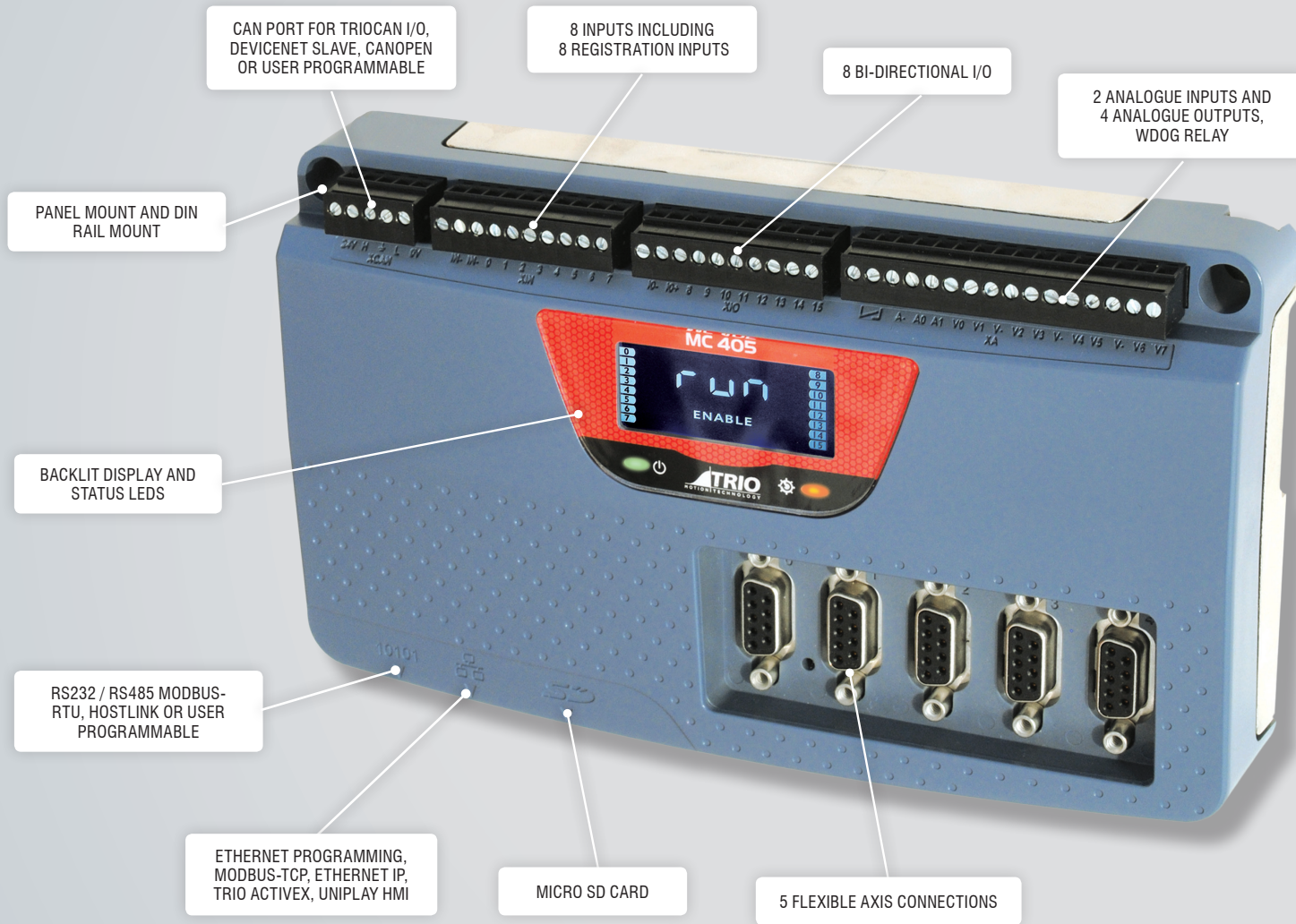

- ## FEATURES
- * Advanced 4 Axis Closed Loop Servo / 5 Axis Pulse Direction
 - * Linear, Circular, Helical and Spherical Interpolation
 - * Flexible CAM shapes, Linked Motion
 - * EnDAT and SSI Absolute Encoder Supported
 - * Hardware Linked Outputs for Camera / Laser Control
 - * Ethernet-IP / Modbus TCP / Ethernet Interface Built-In
 - * 125 – 2000µsec Selectable Servo Update
 - * Precise 64 bit Motion Calculations on ARM11 Processor with VFP
 - * IEC 61131-3 Programming
 - * Multi-tasking BASIC Programming
 - * Text File Handling
 - * Robotic Transformations
 - * Micro SD Memory Card Slot
 - * CANopen I/O Expansion
 - * Backlit LCD Display
 - * RoHS, UL and CE Approved

The MC405 is a high specification *Motion Coordinator* using a high performance ARM11 processor, with five flexible axis ports and four Voltage outputs in 2 model variants.

The flexible axis ports can be configured in software as feedback devices or pulse direction outputs. As outputs they can be used as pulse and direction with stepper or servo drives or they can operate as a simulated encoder output. When configured as feedback they can be either incremental encoder input or one of three popular absolute encoder types; SSI, Tamagawa or EnDat. Any feedback axis with a voltage output can be used to form a closed loop servo.

The built-in Ethernet port allows programming and connection of common HMI and PLC protocols directly to the MC405. User programs can be written in Trio's established multi-tasking TrioBASIC language using the powerful *Motion Perfect v4* application development software making complex motion easy. Also available are the industry standard IEC 61131-3 languages allowing a fully functional PLC programming system.

The MC405 is available in 2 different axis configurations (P826 and P827). Both models feature a total of 16 axes in software. Any axes not assigned to built-in hardware can be used as a virtual axis. Every axis can be programmed to move using linear, circular, helical or spherical interpolation, electronic cams, linked axes and gearboxes.

A bright easy to read backlit display enables the controller status to be easily determined, whilst the single piece metal cast backplate provides an integrated earth chassis to improve noise rejection in the industrial environment.

ACCESSORIES:

P317 - P327	CAN I/O Modules
P750	Kinematic Runtime FEC
P843 - P844	UNIPLAY 7" & 10" HMI's

OVERALL DIMENSIONS:

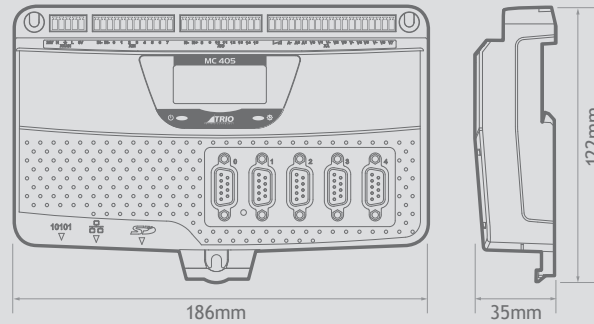

MC405 PRODUCT OPTIONS

	P826	P827
Axis 0	Core	Extended + AS
Axis 1	Core	Extended + AS
Axis 2	Core	Extended + AS
Axis 3	Core	Extended + AS
Axis 4	Core	Extended

CORE AXES – can be configured in software as pulse and direction outputs to stepper or servo drives. They can also be configured for incremental encoder feedback or simulated encoder output.

EXTENDED AXES – in addition to the Core functionality these axes can also be configured for SSI, Tamagawa or EnDat absolute encoders.

AS - Analogue 'closed loop' Servo using built-in $\pm 10V$ analogue output.

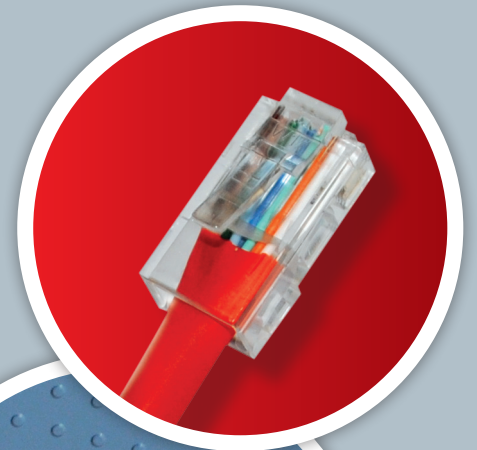

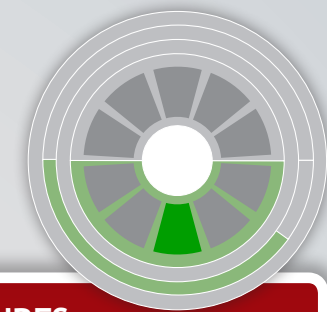

MC508

8/16 Axis Motion Coordinator

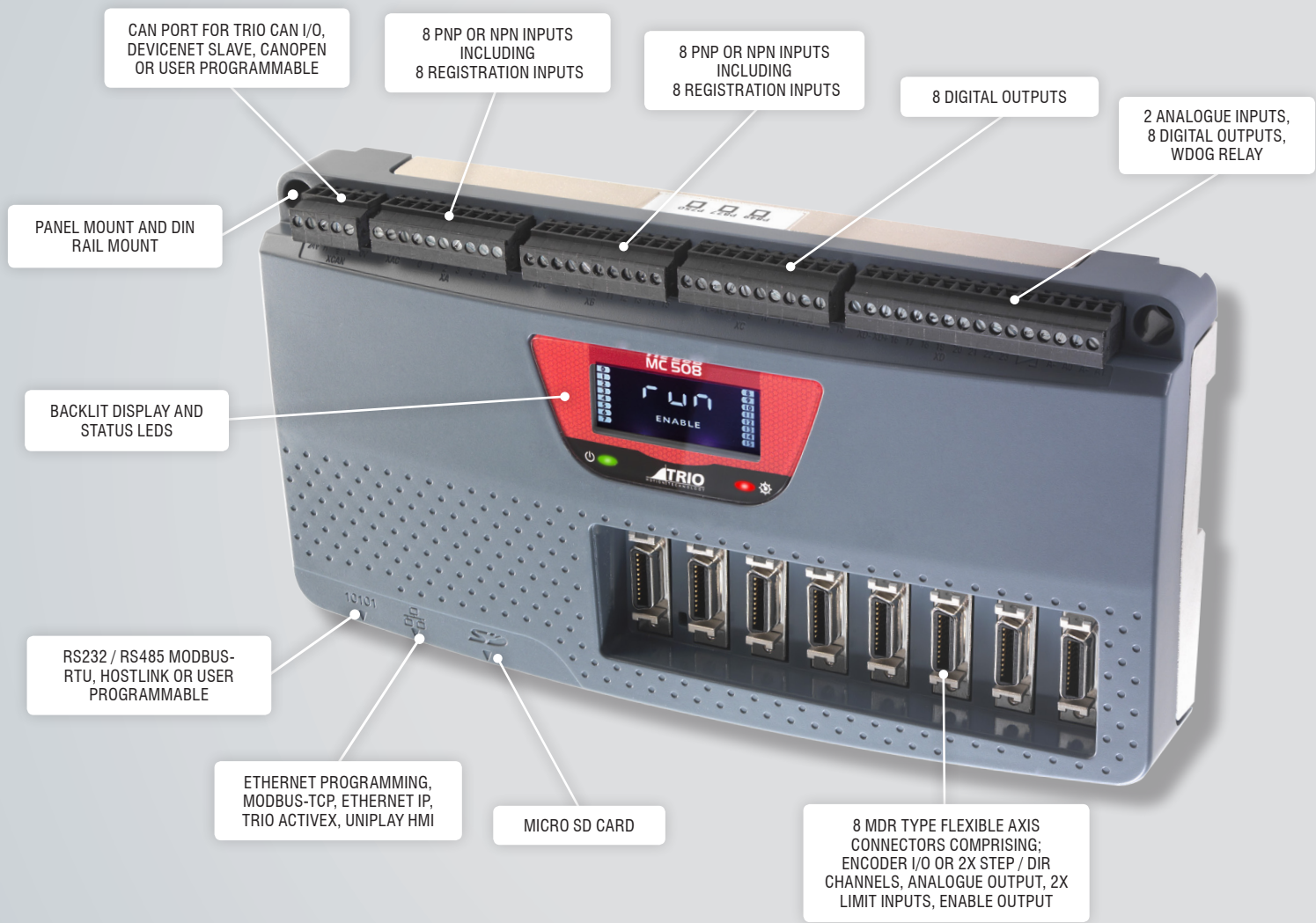

- ### FEATURES
- * Advanced 8 Axis Closed Loop Servo / 16 Axis Pulse Direction
 - * Total of 32 Digital Inputs and 16 Digital Outputs
 - * Linear, Circular, Helical and Spherical Interpolation
 - * Flexible CAM shapes, Linked Motion
 - * EnDAT, BiSS and SSI Absolute Encoder Supported
 - * Hardware Linked Outputs for Camera / Laser Control
 - * Ethernet-IP / Modbus TCP / Ethernet Interface Built-In
 - * 125 – 2000µsec Selectable Servo Update
 - * Precise 64 bit 800 MHz Motion Calculations on ARM A9 Processor with VFP
 - * IEC 61131-3 Programming
 - * Multi-tasking BASIC Programming
 - * Text File Handling
 - * Robotic Transformations
 - * Micro SD Memory Card Slot
 - * CANopen I/O Expansion
 - * Backlit LCD Display
 - * RoHS, UL and CE Approved

The MC508 is a high specification *Motion Coordinator* using a high performance ARM Cortex A9 800 Mhz Processor, with eight Voltage analogue outputs and eight flexible axis ports, that can be configured for up to sixteen pulse and direction output axes or eight closed loop servo axes. It boasts 128 MBytes of RAM; 32 of which is for user programs and user table space.

The flexible axis MDR type connectors allow single cable connection from the MC508 to your drive. The port can be configured in software as feedback devices or pulse direction outputs. As outputs they can be used as pulse and direction with stepper or servo drives or they can operate as a simulated encoder output. When configured as feedback they can be either incremental encoder input or one of four popular absolute encoder types; SSI, BiSS, Tamagawa or EnDAT. All feedback axes can be used to form a closed loop servo with a analogue output.

The built-in Ethernet port allows programming and connection of common HMI and PLC protocols directly to the MC508. User programs can be written in Trio's established multi-tasking TrioBASIC language using the powerful *Motion Perfect v4* application development software making complex motion easy. Also available are the industry standard IEC 61131-3 languages allowing a fully functional PLC programming system.

The MC508 is available in 2 different axis configurations. Both models feature a total of 32 axes in software. Any axes not assigned to built-in hardware can be used as a virtual axis. Every axis can be programmed to move using linear, circular, helical or spherical interpolation, electronic cams, linked axes and gearboxes.

A bright easy to read backlit display enables the controller status to be easily determined, whilst the single piece metal cast backplate provides an integrated earth chassis to improve noise rejection in the industrial environment.

ACCESSORIES:

P317 - P327	CAN I/O Modules
P750	Kinematic Runtime FEC
P843 - P844	UNIPLAY 7" & 10" HMI's

OVERALL DIMENSIONS:

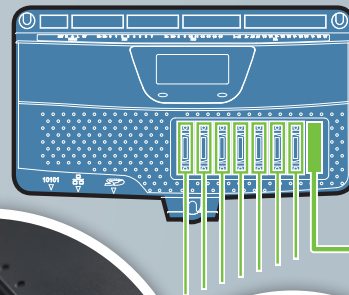
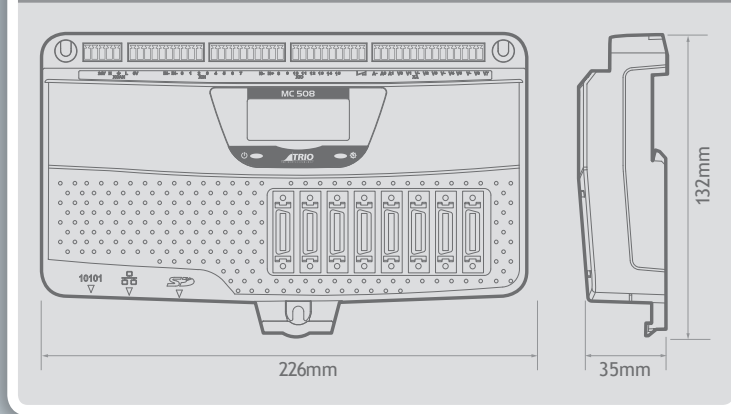

- * +/-10 Volts
- * Encoder
- * Enable Outputs
- * Axis Inputs

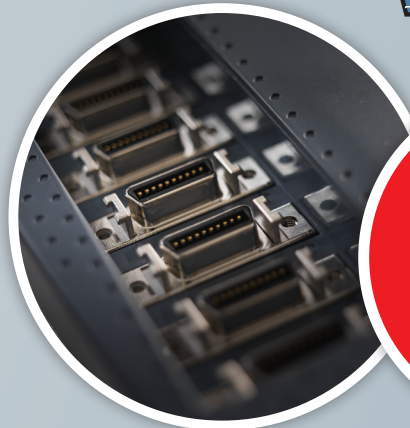

Easy Plug and play to your drive using MDR Connectors.

MC508 PRODUCT OPTIONS

	P848	P849
Axis 0	Core	Extended + AS
Axis 1	Core	Extended + AS
Axis 2	Core	Extended + AS
Axis 3	Core	Extended + AS
Axis 4	Core	Extended + AS
Axis 5	Core	Extended + AS
Axis 6	Core	Extended + AS
Axis 7	Core	Extended + AS
Axis 8	-	Step / Dir Only
Axis 9	-	Step / Dir Only
Axis 10	-	Step / Dir Only
Axis 11	-	Step / Dir Only
Axis 12	-	Step / Dir Only
Axis 13	-	Step / Dir Only
Axis 14	-	Step / Dir Only
Axis 15	-	Step / Dir Only

CORE AXES – can be configured in software as pulse and direction outputs to stepper or servo drives. They can also be configured for incremental encoder feedback or simulated encoder output.

EXTENDED AXES – in addition to the Core functionality these axes can also be configured for SSI, Tamagawa, BiSS or EnDat absolute encoders.

AS - Analogue 'closed loop' Servo using built-in $\pm 10V$ analogue output.

Euro404 Euro408

Motion Coordinator

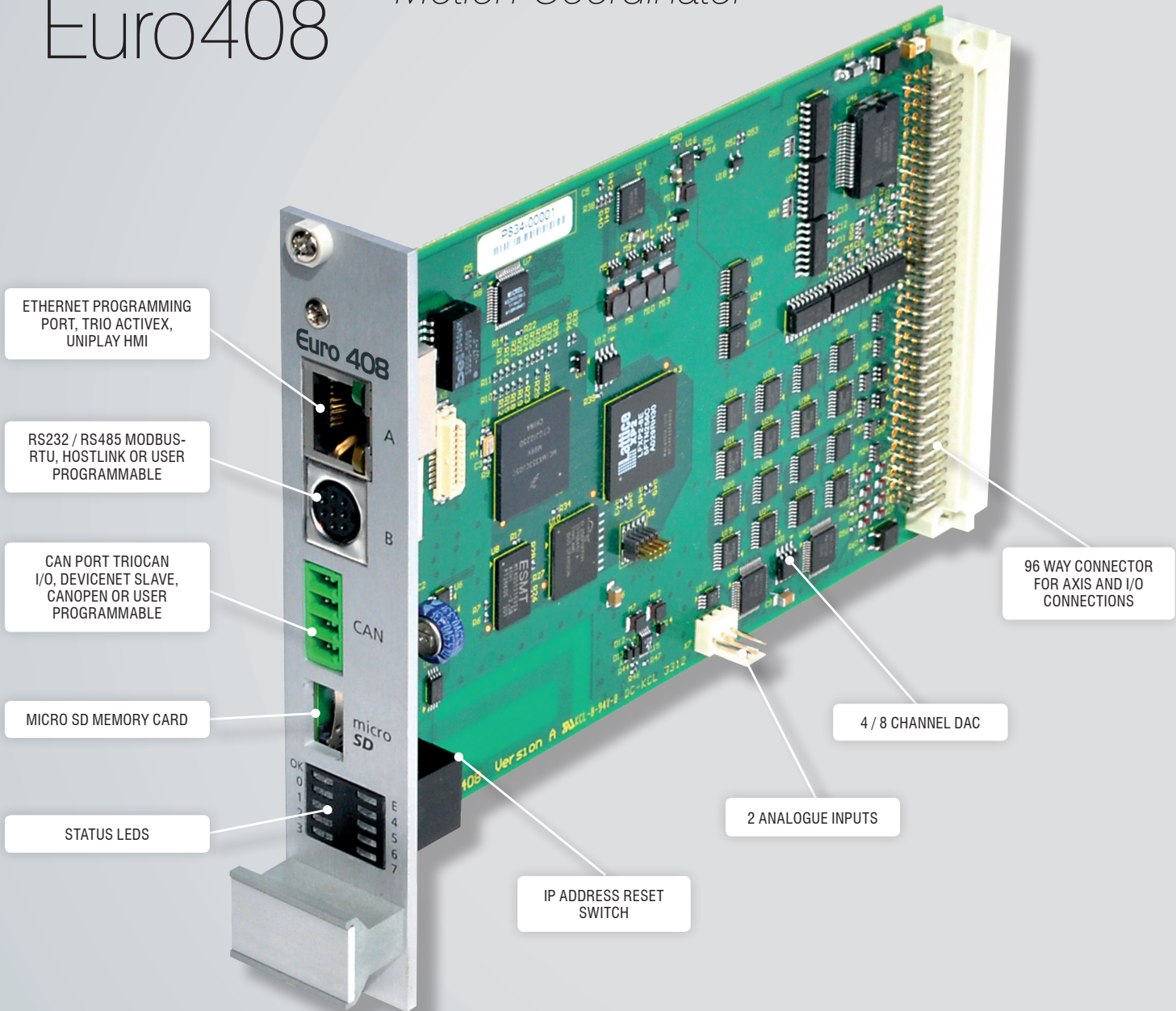
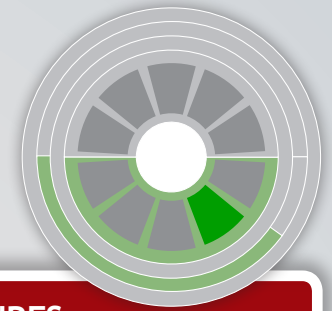

FEATURES

- * Linear, Circular, Helical and Spherical Interpolation
- * Flexible CAM shapes, Linked Motion
- * EnDAT and SSI Absolute Encoder Supported
- * Hardware Linked Outputs for Camera / Laser Control
- * Ethernet-IP / Modbus TCP / Ethernet Interface Built-In
- * 125 – 2000 μ sec Selectable Servo Update
- * Precise 64 bit Motion Calculations on ARM11 Processor with VFP
- * IEC 61131 Programming
- * Multi-tasking BASIC Programming
- * Text File Handling
- * Robotic Transformations
- * Micro SD Memory Card Slot
- * CANopen I/O Expansion
- * 3U Rack Mount Format
- * RoHS and CE Approved

The Euro404 and Euro408 *Motion Coordinators* are designed to provide a powerful yet cost effective control solution for OEM machine builders that are prepared mount the unit and provide the power supplies required.

Both the Euro404 and Euro408 are high specification *Motion Coordinators* using a high performance ARM11 processor, with up to 4 / 8 flexible axis ports and 4 / 8 Voltage outputs respectively. The flexible axis ports can be configured in software as feedback devices or pulse direction outputs. As outputs they can be used as pulse and direction with stepper or servo drives or they can operate as a simulated encoder output. When configured as feedback they can be either incremental encoder input or one of three popular absolute encoder types; SSI, Tamagawa or Endat. Any feedback axis with a Voltage output can be used to form a closed loop servo.

The built-in Ethernet port allows programming and connection of common HMI and PLC protocols directly to the *Motion Coordinator*. User programs can be written in Trio's established multi-tasking TrioBASIC language using the powerful *Motion Perfect v4* application development software making complex motion easy. Also available as an option are the industry standard IEC 61131-3 languages allowing a fully functional PLC programming system.

The Euro404 / 408 are each available in 2 different axis configurations. All models feature a total of 16 axes in software. Any axes not assigned to built-in hardware can be used as a virtual axis. Every axis can be programmed to move using linear, circular or helical or spherical interpolation, electronic cams, linked axes and gearboxes.

ACCESSORIES:

P317 - P327	CAN I/O Modules
P446	Euro Breakout Board
P750	Kinematic Runtime FEC
P843 - P844	UNIPLAY 7" & 10" HMI's

OVERALL DIMENSIONS

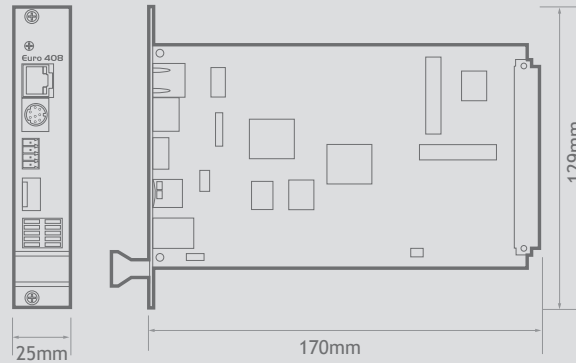

EURO404 PRODUCT OPTIONS

	P831	P832
Axis 0	Core	Extended + AS
Axis 1	Core	Extended + AS
Axis 2	Core	Extended + AS
Axis 3	Core	Extended + AS
Axis 4		
Axis 5		
Axis 6		
Axis 7		

EURO408 PRODUCT OPTIONS

P833	P834
Core	Extended + AS
Core	Extended + AS
Core	Extended + AS
Core	Extended + AS
Core	Extended + AS
Core	Extended + AS
Core	Extended + AS
Core	Extended + AS

CORE AXES – can be configured in software as pulse and direction outputs to stepper or servo drives. They can also be configured for incremental encoder feedback or simulated encoder output.

EXTENDED AXES – in addition to the Core functionality these axes can also be configured for SSI, Tamagawa or Endat absolute encoders.

AS - Analogue 'closed loop' Servo using built-in $\pm 10V$ analogue output.

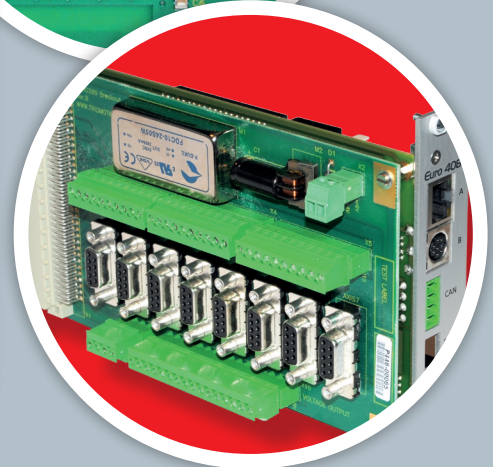
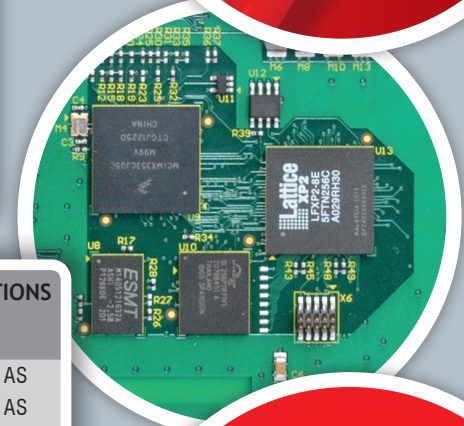
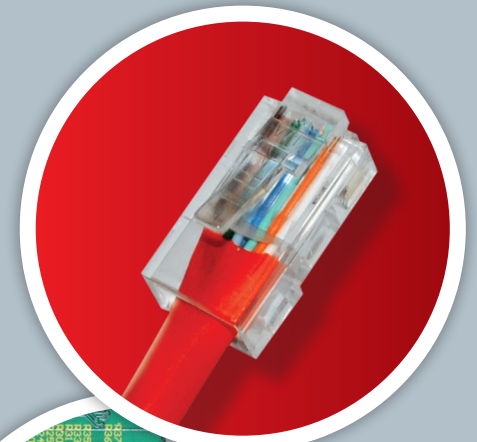

MC4N-RTEX

RTEX Motion Coordinator

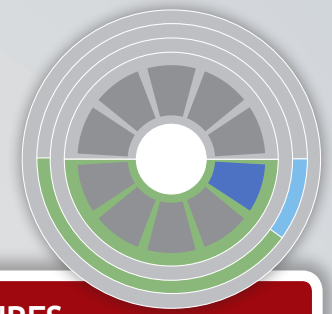

The MC4N-RTEX extends the MC4N range of *Motion Coordinators* for networked drives which started with the MC4N-ECAT. It is dedicated to running remote servo drives via Panasonic's RTEX Real Time EXpress automation bus. It is based on an up-rated version of the 532MHz ARM processor with VFP3.

The MC4N-RTEX supports up to 32 axes of motion with 64 bit integer position registers for ultra precise axis resolution. RTEX slave drives and I/O can be connected and run in cyclic synchronous position, speed or torque modes. Programming the MC4N is identical to using traditional analogue axes with the addition of being able to set up drives and process alarms over the RTEX bus. With everything programmed from one place, machine control has never been so simple.

Panasonic
RTEX
Realtime Express

FEATURES

- ★ Up to 32 RTEX Digital Drive Axes
- ★ Up to 1024 I/O
- ★ Linear, Circular, Helical and Spherical Interpolation
- ★ Flexible CAM shapes, Linked Motion
- ★ Isolated Encoder Port
- ★ EnDAT and SSI Absolute Encoder Supported
- ★ Hardware Linked Output for Camera / Laser Control
- ★ Ethernet-IP / Modbus TCP / Trio ActiveX / Uniplay HMI / UDP / Ethernet Interface Built-In
- ★ Precise 64Bit Motion Calculations with 532MHz ARM 11 Processor
- ★ IEC 61131-3 Programming
- ★ Multi-tasking BASIC Programming
- ★ Text File Handling
- ★ Robotic Transformations
- ★ 4 High Speed Registration Inputs
- ★ Isolated RS232 and RS485 ports
- ★ SD Memory Card Slot
- ★ CANopen I/O Expansion
- ★ Backlit LCD Display
- ★ RoHS, UL and CE Approved

The built-in Ethernet port allows programming and connection of common PLC and HMI protocols, including the Trio UNIPLAY range of HMIs, directly to the MC4N. User programs can be written in Trio's established multi-tasking TrioBASIC language using the powerful *Motion Perfect v4* application development software making complex motion easy. The industry standard IEC 61131-3 languages are available as an option, allowing a fully functional PLC programming system.

Versions of the MC4N are available for 2, 4, 8, 16 and 32 motor axes. All versions feature 32 software axes any of which may be used as virtual axes if not assigned to RTEX hardware. Every axis can be programmed to move using linear, circular or helical or spherical interpolation, electronic cams, linked axes and gearboxes. The power of the controller allows for multiple robotic transformations to run simultaneously.

A bright easy to read backlit display enables the controller status to be easily determined, whilst the single piece metal cast backplate provides an integrated earth chassis to improve noise rejection in the industrial environment.



OVERALL DIMENSIONS:

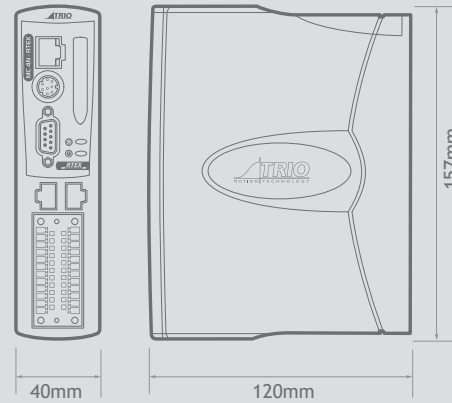

ACCESSORIES:

- | | |
|-------------|------------------------|
| P317 - P327 | CAN I/O Modules |
| P750 | Kinematic Runtime FEC |
| P843 - P844 | UNIPLAY 7" & 10" HMI's |

PRODUCT CODES:

- | | |
|------|-------------------|
| P906 | MC4N-RTEX 2 Axis |
| P907 | MC4N-RTEX 4 Axis |
| P908 | MC4N-RTEX 8 Axis |
| P909 | MC4N-RTEX 16 Axis |
| P910 | MC4N-RTEX 32 Axis |

MC4N - MINI MASTER RANGE:

- | | |
|-----------|----------------------|
| MC4N-RTEX | Mini RTEX Master |
| MC4N-ECAT | Mini EtherCAT Master |

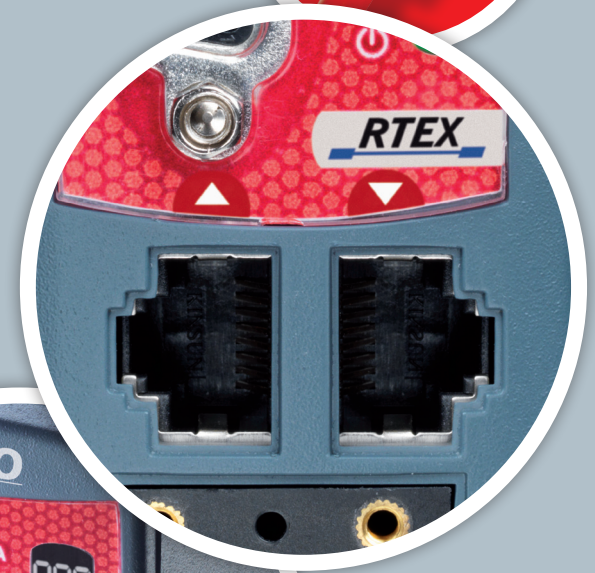

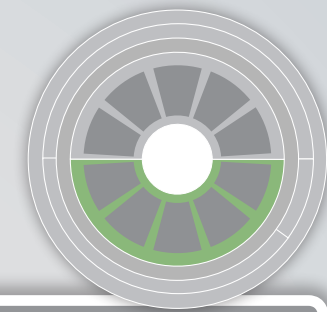

CAN I/O Modules

Trio Motion Technology's range of digital and analogue input/output expansion modules are designed to enable simple and scalable and low-cost I/O extension for Trio's *Motion Coordinators*. In addition to 24V input, output and bi-directional modules, there are relay and analogue I/O modules.

CANbus is used for communication and control between the *Motion Coordinator* and the CAN I/O modules. CANbus is a tried and tested, well known data link in industry which is reliable, noise immune and flexible. All CAN I/O modules are compatible with any *Motion Coordinator* that has a CANbus port.

As well as being able to connect to any *Motion Coordinator* using Trio's own high speed CANbus protocol, each CAN module can run the DS401 CANopen protocol allowing them to be used with other CANopen masters. Protocol selection is by DIP switches on the front of the module.

When using the TrioCANbus protocol, a *Motion Coordinator* can handle up to 16 Digital Input modules and 16 Digital Output modules, a total of 32 Digital modules and 4 Analogue modules. The CAN 16 I/O module counts as one Input and one Output module.

P317: CAN 16-OUT DIGITAL

The Trio CAN 16 Output modules can provide up to 256 distributed output channels at 24Vdc level.

Outputs	16 x 24V sourcing (PNP) output channels
Configuration	2 x 8 output channels
Output Capacity	1A per bank of 8 250mA/channel
Network Speed	500KBit/s
Protocols	TrioCAN I/O / CANopen DS401
Compliance	RoHS, CE and UL

P318: CAN 16-IN DIGITAL

The Trio CAN 16 Input modules can provide up to 256 distributed input channels at 24Vdc level.

Inputs	16 x 24V sourcing (PNP) input channels
Configuration	2 x 8 input channels
Network Speed	500KBit/s
Protocols	TrioCAN I/O / CANopen DS401
Compliance	RoHS, CE and UL

P319: CAN 16-IN / OUT DIGITAL

The Trio CAN 16 Input / Output modules can provide up to 256 distributed bi-directional I/O channels at 24Vdc level.

Inputs	16 x 24V Input channels with 2500V isolation
Outputs	16 x 24V sourcing (PNP) output channels
Configuration	2 x 8 bi-directional input/output channels
Output Capacity	1A per bank of 8 250mA/channel.
Network Speed	500KBit/s
Protocols	TrioCAN I/O / CANopen DS401
Compliance	RoHS, CE and UL

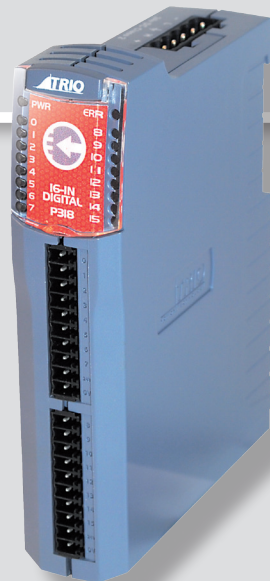

P326: CAN 8-IN/4-OUT ANALOGUE I/O

The Trio CAN Analogue I/O modules can provide up to 32 analogue input and 16 output channels.

Inputs	8 x ± 10V inputs with isolation from CANbus
Outputs	4 x ± 10V outputs with isolation from CANbus
Network Speed	500KBit/s
Protocols	TrioCAN I/O / CANopen DS401
Compliance	RoHS, CE and UL



P327: CAN 8-RELAY OUT

The Trio CAN 8 Relay modules can provide 128 distributed low power relay channels per *Motion Coordinator*.

Outputs	8 x relays 30Vdc / 49V ac
Configuration	4 x NO+NC contacts and 4 x NO only contacts
Network Speed	500KBit/s
Protocols	TrioCAN I/O / CANopen DS401
Compliance	RoHS, CE and UL



OVERALL DIMENSIONS

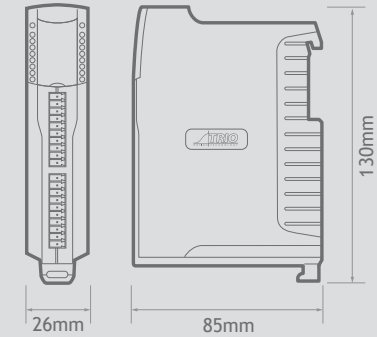

Custom Products

Trio is an independent motion control technology company that concentrates 100% on developing 'motion control products'. Our dedicated and focused approach allows us to design products that fit our customers' needs whether the customer

is a machine builder requiring a bespoke *Motion Coordinator* or a drives company requiring a badged or licenced product.

Custom Boards

Sometimes standard Trio products do not have the exact features required by OEMs. In such cases where a machine builder has a specific requirement for 200+ controllers per year we can design and manufacture a 'bespoke' *Motion Coordinator*.

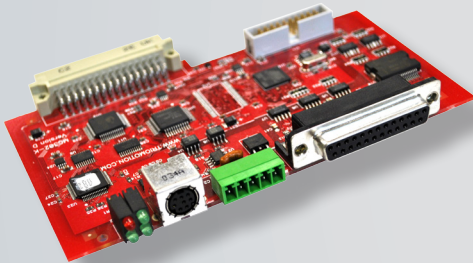

Custom FPGA

OEMs manufacturing specialist machines may require features that are not available in the standard Trio firmware. In this instance Trio offers the ability to program the controller FPGA to suit your needs.

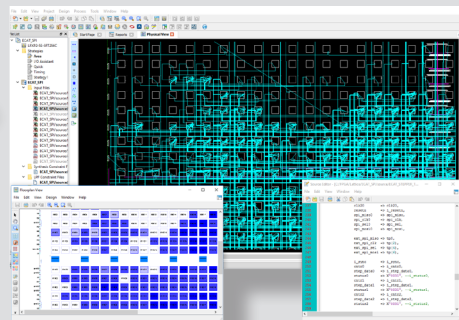

Badged Products

For Drive companies and larger OEMs, we can supply our products badged with your company logo and colours. Custom features can also be incorporated to differentiate your product version from the standard Trio product.



Licensed Products

For companies wishing to fully integrate a motion control product line but not wishing to develop the technology in-house Trio can provide a cost effective solution by designing a custom motion control range that can be manufactured under license.



THE TRIO NETWORK

Trio Worldwide

With offices in Tewkesbury (UK), Pittsburgh (USA), Pune (India) and Shanghai (China), Trio Motion Technology supplies its entire product range worldwide via a network of fully supported distributors.

- | | |
|----------------|----------------|
| Argentina | Netherlands |
| Australia | New Zealand |
| Belgium | Norway |
| Brazil | Poland |
| Canada | Portugal |
| CHINA | Romania |
| Czech Republic | Singapore |
| Denmark | South Africa |
| Finland | Slovakia |
| France | Slovenia |
| Germany | Spain |
| Greece | Sweden |
| Hungary | Switzerland |
| INDIA | Thailand |
| Irish Republic | Taiwan |
| Israel | Turkey |
| Italy | UNITED KINGDOM |
| Korea | UAE |
| Malaysia | USA |
| Mexico | |





TRIO MOTION TECHNOLOGY PRODUCT BROCHURE

MOTION COORDINATOR | I/O DEVICES | HMI | SOFTWARE

TRIO MOTION TECHNOLOGY
UK | USA | CHINA | INDIA
WWW.TRIOACTION.COM
THE MOTION SPECIALIST

Trio Motion Technology's range of *Motion Coordinators*, expansion interfaces, I/O modules and HMI's are designed to enable the control of industrial machines with the minimum of external components. In many applications, Trio's product range can be combined to build a control system capable of driving a multi axis machine and all its auxiliary equipment.

The Trio concept is complemented by a range of software programs designed to work seamlessly with the hardware for unparalleled system performance.

In support of the Trio concept, we aim to offer the best technical support by telephone, email, our comprehensive website and training courses held throughout the year. Please look at our web site for details.

www.triomotion.com

Why Buy Trio?

-  **Learn Only One Programming Environment**
-  **Easy Programming of Complex Motion**
-  **Protect Your Investment With Program Encryption**
-  **Modular Architecture Saves Cost**
-  **Your Choice of Drive Interface**
-  **Your Choice of Factory Communications**
-  **Make Your Machine Perform Faster**
-  **Your Choice of Programming Methods**
-  **Reduce Machine Delivery Times**
-  **We Can Customize and Embed**